

TravelMate 520

Service Guide

Service guide files and updates are available on the AIPG/CSD web; for more information, please refer to <http://csd.acer.com.tw>

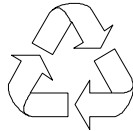

100% Recycled Paper

PART NO.: 49.41H02.001
DOC. NO.: SG336-0005A

PRINTED IN TAIWAN

Copyright

Copyright © 1999 by Acer Incorporated. All rights reserved. No part of this publication may be reproduced, transmitted, transcribed, stored in a retrieval system, or translated into any language or computer language, in any form or by any means, electronic, mechanical, magnetic, optical, chemical, manual or otherwise, without the prior written permission of Acer Incorporated.

Disclaimer

The information in this guide is subject to change without notice.

Acer Incorporated makes no representations or warranties, either expressed or implied, with respect to the contents hereof and specifically disclaims any warranties of merchantability or fitness for any particular purpose. Any Acer Incorporated software described in this manual is sold or licensed "as is". Should the programs prove defective following their purchase, the buyer (and not Acer Incorporated, its distributor, or its dealer) assumes the entire cost of all necessary servicing, repair, and any incidental or consequential damages resulting from any defect in the software.

Acer is a registered trademark of Acer Corporation.

Intel is a registered trademark of Intel Corporation.

Pentium and Pentium II/III are trademarks of Intel Corporation.

Other brand and product names are trademarks and/or registered trademarks of their respective holders.

Conventions

The following conventions are used in this manual:

Screen messages	Denotes actual messages that appear on screen.
NOTE	Gives bits and pieces of additional information related to the current topic.
WARNING	Alerts you to any damage that might result from doing or not doing specific actions.
CAUTION	Gives precautionary measures to avoid possible hardware or software problems.
IMPORTANT	Reminds you to do specific actions relevant to the accomplishment of procedures.

Preface

Before using this information and the product it supports, please read the following general information.

1. This Service Guide provides you with all technical information relating to the BASIC CONFIGURATION decided for Acer's "global" product offering. To better fit local market requirements and enhance product competitiveness, your regional office MAY have decided to extend the functionality of a machine (e.g. add-on card, modem, or extra memory capability). These LOCALIZED FEATURES will NOT be covered in this generic service guide. In such cases, please contact your regional offices or the responsible personnel/channel to provide you with further technical details.
2. Please note WHEN ORDERING FRU PARTS, that you should check the most up-to-date information available on your regional web or channel. If, for whatever reason, a part number change is made, it will not be noted in the printed Service Guide. For ACER-AUTHORIZED SERVICE PROVIDERS, your Acer office may have a DIFFERENT part number code to those given in the FRU list of this printed Service Guide. You MUST use the list provided by your regional Acer office to order FRU parts for repair and service of customer machines.

Chapter 1	System Specifications	1
	Features	1
	System Block Diagram	3
	Board Layout	4
	Panel	6
	Indicators	10
	Keyboard	11
	Touchpad	15
	Hardware Specifications and Configurations	17
Chapter 2	System Utilities	29
	BIOS Setup Utility	29
	BIOS Flash Utility	37
	System Utility Diskette	38
	System Diagnostic Diskette	40
Chapter 3	Machine Disassembly and Replacement	43
	General Information	44
	Disassembly Procedure Flowchart	45
	Removing the Battery Pack	47
	Removing the CD-ROM Drive Module	48
	Removing the Hard Disk Drive Module	49
	Removing the Extended Memory	50
	Removing the Modem Board	51
	Disassembling the LCD	52
	Disassembling the Upper Case	58
	Disassembling the Lower Case	62
Chapter 4	Troubleshooting	67
	System Check Procedures	68
	Index of Error Message	71
	Index of Symptom-to-FRU Error Message	74
	Intermittent Problems	78
	Undetermined Problems	79
	Index of AFlash BIOS Error Message	80
	Index of PQA Diagnostic Error Code, Message	81
Chapter 5	Jumper and Connector Locations	83
	Top View	83
	Bottom View	85
Chapter 6	FRU (Field Replaceable Unit) List	87
Appendix A	Model Definition and Configuration	99
Appendix B	Test Compatible Components	101
Appendix C	Online Support Information	103
Index		105

Table of Contents

System Specifications

Features

This computer was designed with the user in mind. Here are just a few of its many features:

Performance

- Mobile Pentium® III processor with 256KB L2 cache, Mobile Pentium® III processor with 256KB level 2 cache featuring Intel® SpeedStep™ technology with 256KB level 2 cache or Mobile Celeron® processor with 128KB level 2 cache
- 64-bit memory bus
- Built-in floppy disk drive
- Lithium-Ion battery pack
- Power management system with ACPI (Advanced Configuration Power Interface)

Multimedia

- 16-bit high fidelity PCI stereo audio with 3D sound and wavetable synthesizer
- Built-in dual speakers with microphone
- High-speed CD-ROM, DVD-ROM or CD-RW drive
- USB video capture kit option

Connectivity

- High-speed fax/data modem port
- Fast infrared wireless communication
- USB (Universal Serial Bus) port
- Ethernet/Fast Ethernet port

Human-centric Design and Ergonomics

- All-in-one design (CD-ROM, floppy disk drive, hard disk drive)
- Sleek, smooth and stylish design
- Full-sized keyboard
- Ergonomically-centered touchpad pointing device

Expansion

- CardBus PC card (formerly PCMCIA) slots (two type II/I or one type III) with ZV (Zoomed Video) port support (lower slot)
- Upgradeable memory and hard disk
- Port replicator option for one-step connect/disconnect from peripherals

Display

The large graphics display offers excellent viewing, display quality and desktop performance graphics. The computer supports a Thin-Film Transistor (TFT) liquid crystal display (LCD) displaying 24-bit true-color at 800x600 Super Video Graphic Array (SVGA) or 1024x768 eXtended Graphics Array (XGA) resolution.

Video performance

2X AGP video graphic accelerator with 8 MB of video memory boost video performance.

Simultaneous display

The computer's large display and multimedia capabilities are great for giving presentations. If you prefer, you can also connect an external monitor when giving presentations. This computer supports simultaneous LCD and CRT display. Simultaneous display allows you to control the presentation from your computer and at the same time face your audience. You can also connect other output display devices such as LCD projection panels for large-audience presentations.

Dual Display

The computer's unique graphics chip takes advantage of Windows 98 multi-display capability, allowing you to extend your desktop to an external display device, such as an external monitor projector. With this feature enabled, you can move program windows to/from the computer LCD and the external monitor.

Power management

The power management system incorporates an "automatic LCD dim" feature that automatically dims the LCD when the computer is powered by a battery pack to conserve battery power. See "Power Management" on page 26 for more information on power management features.

Opening and closing the display

To open the display, slide the display cover latch to the left and lift up the cover. Then tilt it to a comfortable viewing position. The computer employs a microswitch that turns off the display (and enters standby mode) to conserve power when you close the display cover, and turns it back on when you open the display cover.

NOTE: If an external monitor is connected, the computer turns off the display (but does not enter standby mode) when you close the display cover.

To close the display cover, fold it down gently until the display cover latch clicks into place.

To avoid damaging the display, do not slam it when you close it. Also, do not place any object on top of the computer when the display is closed.

System Block Diagram

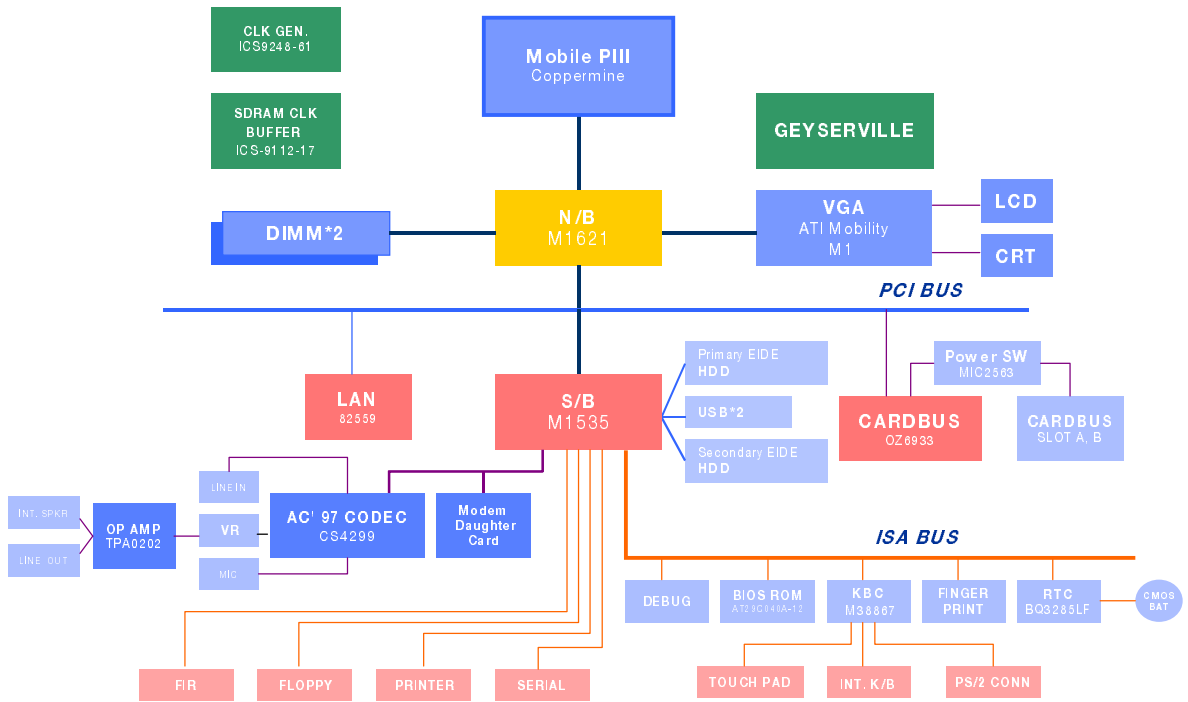

Board Layout

Top View

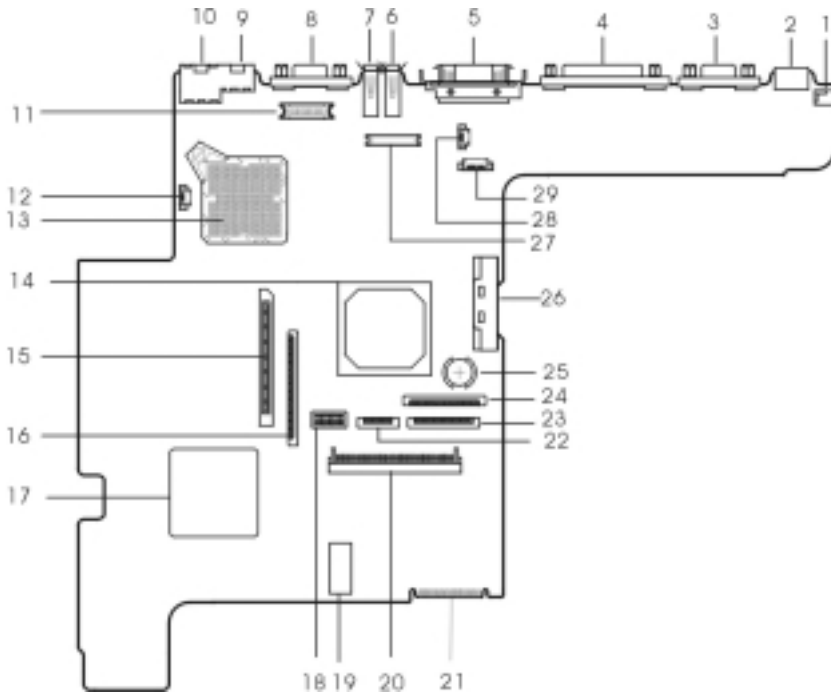

- | | |
|---|---|
| 1. DC-in Port | 16. Diskette Drive Connector |
| 2. PS/2 Keyboard and Mouse Port | 17. PCMCIA (PC card) Controller (OZ6933) |
| 3. Serial Port | 18. Switch |
| 4. Parallel Port | 19. BIOS ROM |
| 5. Expansion Port | 20. HDD Connector |
| 6. USB Port 2 | 21. Golden Finger for Debug |
| 7. USB Port 1 | 22. Touchpad Cable Connector |
| 8. External Display Port | 23. Digital Finger Print Sensor Connector(Not Used) |
| 9. Modem Port | 24. Keyboard Cable Connector |
| 10. LAN Port | 25. RTC Battery |
| 11. LED & Inverter Connector | 26. CD-ROM Connector |
| 12. Fan Connector | 27. LCD Connector |
| 13. CPU Socket | 28. TV BD Connector(Not Used) |
| 14. VGA Controller (ATI Rage Mobility-M1) | 29. Launch Key Connector |
| 15. PCMCIA Socket Connector | |

Bottom View

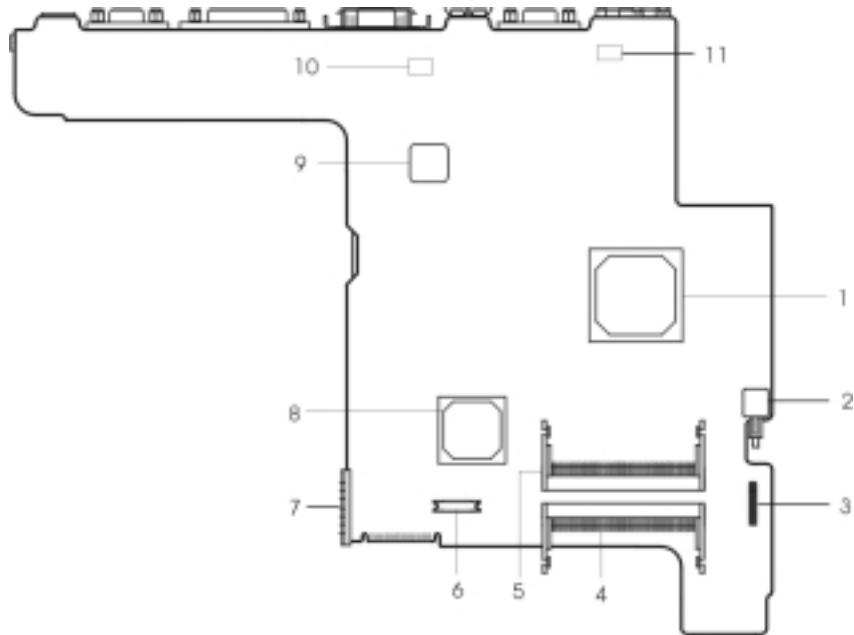

- | | |
|-----------------------------|----------------------------------|
| 1. North Bridge (ALi M1621) | 7. Battery Connector |
| 2. Power Push Switch | 8. South Bridge (ALi M1535) |
| 3. Audio Connector | 9. LAN Controller(Intel GD82559) |
| 4. DIMM 1 Socket | 10. Modem Card Cable Connector |
| 5. DIMM 2 Socket (Reverse) | 11. Modem Card Cable Connector |
| 6. Modem Connector | |

Panel

Ports allow you to connect peripheral devices to your computer as you would with a desktop PC.



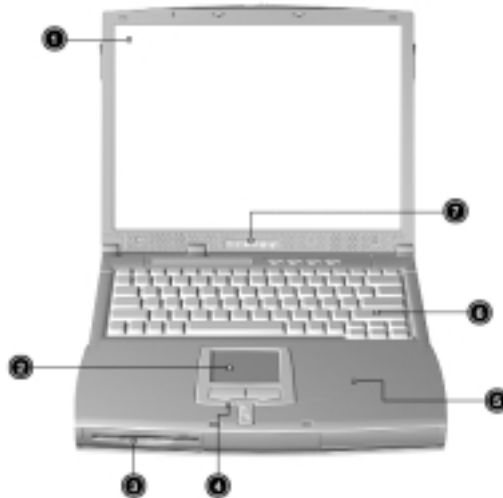

Front Panel



#	Item	Description
1	Display screen	Also called LCD (Liquid Crystal Display), displays computer output.
2	Touchpad	Touch-sensitive pointing device which functions like a computer mouse.
3	Floppy drive	Internal diskette drive, accepts 3.5-inch floppy diskette.
4	Click button (left, center and right)	The left and right buttons function like the left and right mouse buttons, the center button serves as a scroll up/down button.
5	Palmrest	Comfortable support area for your hands when you use the computer.
6	Keyboard	Inputs data into your computer.
7	Status indicator	LEDs (Light Emitting Diodes) that turn on and off to show the status of the computer and its functions and components.

Left Panel



#	Icon	Item/ Port	Connects to...
1		Security keylock	Kensington-compatible key-based computer security lock.
2		PCMCIA (PC card) Port	Two Type I/II or one Type III 16-bit PC card or 32-bit CardBus PC Card.
3		Eject button	Eject PC cards from the card slots.
4		Power switch	Turns on the computer power.
5		Infrared port	Interfaces with Infrared devices (e.g., infrared printer, IR-aware computers).
6		Speaker/ headphone-out jack	Audio line-out devices (e.g., speakers, headphones)
7		Line-in jack	Accepts audio line-in devices (e.g., audio CD player, stereo walkman).
8		Microphone-in jack	Accepts a mono-stereo condenser microphone.
9		Volume control	Controls the volume of the speakers.
10		Video capture kit slot	Accepts the video capture kit option on the left side of the computer.



Right Panel







#	Icon	Item/ Port	Connects to...
1		Video capture kit slot	Accepts the video capture kit option on the right side of the computer.
2		Battery bay	Houses the computer's battery pack.
3		CD-ROM/DVD-ROM/CD-RW Drive	Houses removable media drive modules.
4		LED indicator	Lights up when the AcerMedia drive is active.
5		Eject button	Ejects the compact disc from the drive.
6		Emergency eject slot	Ejects the compact discs when the computer is turned off.
7		DC-in port	AC adapter and power outlet.

Rear Panel



#	Icon	Item/ Port	Connects to...
1		PS/2 keyboard and mouse port	PS/2 compatible device (e.g., PS/2 keyboard/mouse/keypad)
2		Serial port	Serial device (e.g., serial mouse)
3		Parallel port	Parallel device (e.g., parallel printer)

#	Icon	Item/ Port	Connects to...
4		Expansion port	EasyPort port replicator
5		USB ports	Universal Serial Bus devices (e.g., USB mouse, USB camera)
6		External display port	Display device (e.g., external monitor, LCD projector) and displays up to 64K colors at 1280x1024 resolution).
7		Modem port	Phone line
8		LAN port	Ethernet 10/100 based network

Bottom Panel

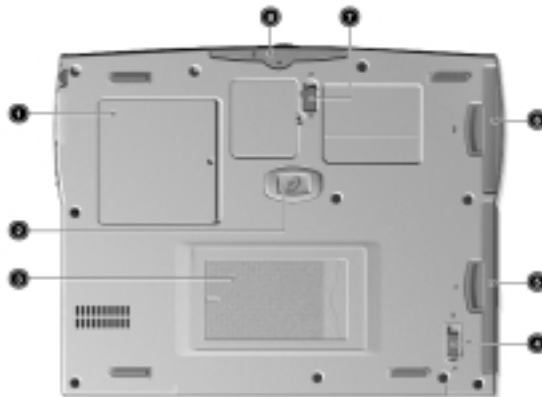







#	Item	Description
1	Memory compartment	Houses the computer's main memory.
2	Hard disk anti-shock protection	Protects your hard disk against shocks.
3	Personal identification slot	Insert a business card or similar-sized identification card to personalize your computer.
4	AcerMedia bay release latch	Unlatches the AcerMedia drive for removal or swapping.
5	AcerMedia bay	Houses an AcerMedia drive module.
6	Battery bay	Houses the computer's battery pack.
7	Battery release latch	Unlatches the battery to remove the battery pack.
8	Hard disk bay	Houses the computer's hard disk (secured by a screw).

Indicators

The computer has six easy-to-read status icons below the display screen.



The Power and Sleep status icons are visible even when you close the display cover so you can see the status of the computer while the cover is closed.

#	Icon	Function	Description
1		Power	Lights when the computer is on.
2		Sleep	Lights when the computer enters Sleep Mode.
3		Media Activity	Lights when the floppy disk drive, hard disk drive or AcerMedia drive is active.
4		Battery Charge	Lights when the battery is being charged.
5		Caps Lock	Lights when Caps Lock is activated.
6		Num Lock	Lights when Num Lock is activated.

Keyboard

The keyboard has full-sized keys and an embedded keypad, separate cursor keys, two Windows keys and twelve function keys.

Special keys

Lock keys

The keyboard has three lock keys which you can toggle on and off.

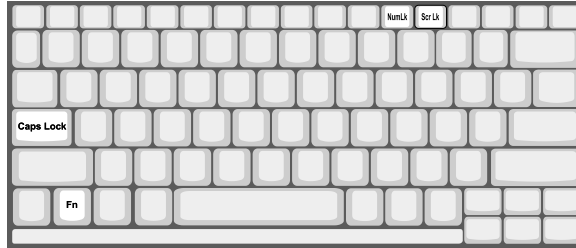

Lock key	Description
Caps Lock	When Caps Lock is on, all alphabetic characters typed are in uppercase.
Num Lock (Fn-F11)	When Num Lock is on, the embedded keypad is in numeric mode. The keys function as a calculator (complete with the arithmetic operators +, -, *, and /). Use this mode when you need to do a lot of numeric data entry. A better solution would be to connect an external keypad.
Scroll Lock (Fn-F12)	When Scroll Lock is on, the screen moves one line up or down when you press the up or down arrow keys respectively. Scroll Lock does not work with some applications.

Embedded numeric keypad

The embedded numeric keypad functions like a desktop numeric keypad. It is indicated by small characters located on the upper right corner of the keycaps. To simplify the keyboard legend, cursor-control key symbols are not printed on the keys.





Desired access	Num lock on	Num lock off
Number keys on embedded keypad	Type numbers in a normal manner.	
Cursor-control keys on embedded keypad	Hold Shift while using cursor-control keys.	Hold Fn while using cursor-control keys.
Main keyboard keys	Hold Fn while typing letters on embedded keypad.	Type the letters in a normal manner.

NOTE: If an external keyboard or keypad is connected to the computer, the Num Lock feature automatically shifts from the internal keyboard to the external keyboard or keypad.

Windows keys

The keyboard has two keys that perform Windows-specific functions.



Keys	Description
Windows logo key 	Start button. Combinations with this key perform shortcut functions. Below are a few examples: Ⓜ + Tab (Activates next taskbar button) Ⓜ + E (Explores My Computer) Ⓜ + F (Finds Document) Ⓜ + M (Minimizes All) Shift + Ⓜ + M (Undoes Minimize All) Ⓜ + R (Displays the Run... dialog box)
Application key 	Opens a context menu (same as a right-click).











Hot Keys

The computer employs hot keys or key combinations to access most of the computer's controls like screen brightness, volume output and the BIOS Utility.

To activate hot keys, press and hold the Fn key before pressing the other key in the hot key combination.



Hot key	Icon	Function	Description
Fn-F1	?	Hot Key Help	Displays help on hot keys.
Fn-F2		Setup	Accesses the computer's configuration utility.

Hot key	Icon	Function	Description
Fn-F3		Power Management Scheme Toggle	Switches the power management scheme used by the computer (function available if supported by operating system)
Fn-F4		Sleep	Puts the computer in Sleep mode.
Fn-F5		Display Toggle	Switches display output between the display screen, external monitor (if connected) and both the display screen and external monitor.
Fn-F6		Screen Blank	Turns the display screen backlight off to save power. Press any key to return.
Fn-F7		Touchpad Toggle	Turns the internal touchpad on and off.
Fn-F8		Speaker Toggle	Turns the speakers on and off.
Fn-←		Brightness Down	Decreases the screen brightness.
Fn-→		Brightness Up	Increases the screen brightness.
Fn-↑		Contrast Up	Not applicable, because the contrast level of TFT display is already optimized.
Fn-↓		Contrast Down	Not applicable, because the contrast level of TFT display is already optimized.
Alt Gr-Euro		Euro	Types the euro symbol.

The euro symbol

If your keyboard layout is set to United States-International or United Kingdom or if you have a keyboard with a European layout, you can type the Euro symbol on your keyboard.

NOTE: For US keyboard users: The keyboard layout is set when you first set up Windows. For the Euro symbol to work, the keyboard layout has to be set to United States-International.

To verify the keyboard type:

1. Click on **Start, Settings, Control Panel**.
2. Double-click on **Keyboard**.
3. Click on the **Language** tab.
4. Verify that the keyboard layout used for "English (United States)" is set to United States-International.

If not, select and click on **Properties**; then select **United States-International** and click on **OK**.

5. Click on **OK**.

To type the Euro symbol:

1. Locate the Euro symbol on your keyboard.
2. Open a text editor or word processor.
3. Hold **Alt Gr** and press the Euro symbol.

NOTE: Some fonts and software do not support the Euro symbol. Please refer to <http://www.microsoft.com/typography/faq/faq12.htm> for more information.

Launch Keys

Located at the top of the keyboard are four buttons. These buttons are called launch keys. They are designated as key 1, key 2, key 3 and key 4. By default, key 1 is used to launch the internet browser and key 2 is used to launch the e-mail application. Keys 3 and 4 starts the Launch Manager application. All four keys can be set by the user. To set the launch keys, run the Acer Launch Manager.



Touchpad

The built-in touchpad is a PS/2-compatible pointing device that senses movement on its surface. This means that the cursor responds as you move your finger on the surface of the touchpad. The central location on the palmrest provides optimum comfort and support.

NOTE: When using an external USB or serial mouse, you can press **Fn-F7** to disable the touchpad. If you are using an external PS/2 mouse, the touchpad is automatically disabled.



Touchpad basics

The following items teach you how to use the touchpad:



1. Move your finger across the touchpad to move the cursor.
2. Press the left (1) and right (3) buttons located on the edge of the touchpad to do selection and execution functions. These two buttons are similar to the left and right buttons on a mouse. Tapping on the touchpad produces similar results.
3. Use the center (2) buttons (top and bottom) to scroll up or down a page. This button mimics your cursor pressing on the right scroll bar of Windows applications.

Function	Left Button	Right Button	Center Button	Tap
Execute	Click twice quickly			Tap twice (at the same speed as double-clicking a mouse button)
Select	Click once			Tap once
Drag	Click and hold, then use finger to drag the cursor on the touchpad			Tap twice (at the same speed as double-clicking a mouse button) then hold finger to the touchpad on the second tap and drag the cursor
Access context menu		Click once		
Scroll			Click and hold the up/down buttons	

NOTE: Keep your fingers dry and clean when using the touchpad. Also keep the touchpad dry and clean. The touchpad is sensitive to finger movements. Hence, the lighter the touch, the better the response. Tapping harder will not increase the touchpad's responsiveness.

Hardware Specifications and Configurations

Main board Major Chips

Item	Controller
System core logic	ALi M1621/M1535
Super I/O controller	ALi M1535
Audio controller	ALi M1535 + Cirrus Logic CS4299
Video controller	ATI Rage Mobility-M1
IDE controller	ALi M1535
Keyboard controller	M38867
RTC	BQ3285LF
PCMCIA Controller	O2 OZ6933

Processor

Item	Specification
CPU type	Intel Mobile Pentium III/Celeron 500/500+ MHz with 256KB/128KB on-die cache
CPU package	uPGA2 package
CPU core voltage	1.6V / 1.35V
CPU I/O voltage	1.5V

BIOS

Item	Specification
BIOS vendor	Acer
BIOS version	V3.0
BIOS ROM type	Flash ROM
BIOS ROM size	512KB
BIOS package	32-pin TSOP
Supported protocols	ACPI 1.0b, APM 1.2, PC Card 95, SM BIOS 2.3, EPP/IEEE 1284, ECP/IEEE 1284 1.7 & 1.9, IrDA, PCI 2.1, PnP 1.0a, PS/2 keyboard and mouse, USB, VESA VGA BIOS, DDC-2B, CD-ROM bootable, Windows keyboard Microsoft Simple Boot Flag
BIOS password control	Set by switch, see SW1 settings

Second Level Cache

Item	Specification
Cache controller	Built-in ALi M1621
Cache size	128KB/256KB
1st level cache control	Always Enabled
2nd level cache control	Always Enabled
Cache scheme control	Fixed-in write back

System Memory

Item	Specification
Memory controller	ALi M1621
Onboard memory size	0 MB

System Memory

Item	Specification
DIMM socket number	2 sockets
Supports memory size per socket	32/64/128/256 MB
Supports maximum memory size	512 MB (256MB x 2)
Supports DIMM type	SDRAM
Supports DIMM speed	100 MHz
Supports DIMM voltage	3.3 V
Supports DIMM package	144 pin so-DIMM
Memory module combinations	You can install memory modules in any combinations as long as they match the above specifications.

Memory Combinations

Slot 1	Slot 2	Total Memory
32 MB	32 MB	64 MB
64 MB	0 MB	64 MB
0 MB	64 MB	64 MB
64 MB	32 MB	96 MB
32 MB	64 MB	96 MB
64 MB	64 MB	128 MB
0 MB	128 MB	128 MB
128 MB	0 MB	128 MB
32 MB	128 MB	160 MB
128 MB	32 MB	160 MB
64 MB	128 MB	192 MB
128 MB	64 MB	192 MB
128 MB	128 MB	256 MB
256 MB	0 MB	256 MB
0 MB	256 MB	256 MB
256 MB	32 MB	288 MB
32 MB	256 MB	288 MB
256 MB	64 MB	320 MB
64 MB	256 MB	320 MB
256 MB	128 MB	384 MB
128 MB	256 MB	384 MB
256 MB	256 MB	512 MB

Above table lists some system memory configurations. You may combine DIMMs with various capacities to form other combinations.

LAN & Modem Interface

Item	Specification
Chipset	M1535/GD 82559
Fax modem data baud rate (bps)	14.4K
Data modem data baud rate (bps)	56K
Supports modem protocol	ITU-T V.90, V.34, TIA/EIA 602
Supports LAN protocol	IEEE 802.3
Modem/LAN connector type	RJ11/RJ45

LAN & Modem Interface

Item	Specification
Modem/LAN connector location	Rear Side

Floppy Disk Drive Interface

Item	Specification		
Vendor & model name	Mitsumi D353F3X		
Floppy Disk Specifications			
Media recognition	2DD(720KB)	2HD(1.2MB, 3-mode)	2HD(1.44MB)
Sectors/track	9	15	18
Tracks	80	80	80
Data transfer rate (Kbit/s)	1MB	1.6MB	2MB
Rotational speed (RPM)	300	360	300
Read/write heads	2		
Encoding method	MFM/FM		
Power Requirement			
Input Voltage (V)	+5V +/- 10%		

Hard Disk Drive Interface

Item	Specification		
Vendor & Model Name	IBM DARA-209000	IBM DARA-212000	Hitachi DK23AA-12
Capacity (GB)	9	12	12
Bytes per sector	512	512	512
Logical heads	16	16	16
Logical sectors	63	63	63
Drive Format			
Logical cylinders	16383	16383	16383
Physical read/write heads	3	4	4
Disks	2	2	2
Spindle speed (RPM)	4200	4200	4200
Performance Specifications			
Buffer size (KB)	418	418	512
Interface	IDE (ATA-4)	IDE (ATA-4)	IDE (ATA-5)
Data transfer rate (disk buffer, MB/s)	85.5-161.6	85.5-161.6	12.4-20.6
Data transfer rate (host buffer, MB/s)	16.6 (PIO Mode-4) 66.6 (Ultra DMA Mode-4)	16.6 (PIO Mode-4) 66.6 (Ultra DMA Mode-4)	16.6 (PIO Mode-4/Multiword DMA Mode-2) 66.6 (Ultra DMA Mode-4)
DC Power Requirements			
Voltage tolerance	5+/-5%	5+/-5%	5+/-5%

CD-ROM Interface

Item	Specification	
Vendor & Model Name	MKE CR-176-B/D 24X	TEAC CD-224E-B26
Performance Specification		
Transfer rate	CAV Mode: 775~1800 blocks/sec Mode 1: 1550~3600 kBytes/sec Mode 2: 1768~4106kBytes/sec	Burst: 33.3 Mbytes/sec Sustained: 1545~3600 kBytes/sec
Access time (typ.)	Random: 100 ms Full Stroke: 200 ms	115 ms
Rotation speed	5000 rpm	5136 rpm
Data Buffer Capacity	128 KB	128 KB
Interface	IDE	IDE
Applicable disc format	CD-Audio, CD-ROM (mode 1 and Mode 2), CD-ROM XA (mode 2, form 1 and form 2), CD-I (mode 2, form 1 and form 2), CD-I Ready, CD-I Bridge, Photo CD, CD-WO, Video CD, Enhanced Music CD (CD Plus), CD-RW	CD-ROM (mode 1 and mode 2), CD-ROM XA (mode 1, form 1 and form2), Photo CD, Enhanced CD, CD-RW
Loading mechanism	Drawer with soft eject and emergency eject hole	
Power Requirement		
Input Voltage	5V+/-5%	5V+/-5%

DVD-ROM Interface

Item	Specification	
Vendor & model name	MKE SR-8174-BXX	
Performance Specification	With CD Diskette	With DVD Diskette
Transfer rate (KB/s)	Average Sustained: CAV mode 775~1800 blocks/sec (10.3X to 24X) 1550~3600 kBytes/sec (Mode 1) 1768~4106 kBytes/sec (Mode 2)	DVD-5: Normal Speed (1X) 11.08 Mbits/sec CAV mode 27.51~66.48 Mbits/sec DVD-9: Normal Speed (1X) 11.08 Mbits/sec CAV mode TBD~TBD Mbits/sec
Access time (typ.)	Random (*1) CAV mode 120 msec typical 180 msec average max Full Stroke (*2) CAV mode 210 msec typical 270 msec average max	Random (*3) 170 msec typical 270 msec average max Full Stroke (*4) 320 msec typical 480 msec average max
Data Buffer Capacity	512 kBytes	
Interface	IDE	
Applicable disc format	DVD: DVD-5, DVD-9, DVD-10, DVD-R (3.95G) CD: CD-Audio, CD-ROM (mode 1 and mode 2), CD-ROM XA (mode 2, form 1 and form 2), CD-I (mode 2, form 1 and form 2), CD-I Ready, CD-I Bridge, CD-WO, CD-RW, Photo CD, Video CD, Enhanced Music CD, CD-TEXT	

DVD-ROM Interface

Item	Specification
Loading mechanism	Soft eject (with emergency eject hole)
Power Requirement	
Input Voltage	5V

Note: (*1) Average of Data read over the whole area from 00 min. 02 sec. 00 block to 59 min. 58 sec. 74 block more than 2000 times including latency and layered error correction time.

(*2) From 00 min. 02 sec. 00 block to 59 min. 58 sec. 74 block including latency and layered error correction time.

(*3) Disc: MNSU-005

(*4) Average of Data read over the whole area from starting data recorded area (LBA:0) to maximum data recorded area (LBA:23197F), more than 2000 times including latency and layered error correction time.

(*5) from starting data recorded area (LBA:0) to maximum data recorded area (LBA:23197F) including latency and layered error correction time.

(*6) Disc: MKE-D551

Audio Interface

Item	Specification
Audio controller	Cirrus Logic CS4299
Audio onboard or optional	Built-in
Mono or Stereo	Stereo
Resolution	20 bit stereo Digital to Analog converter 18 bit stereo Analog to Digital converter
Compatibility	Microsoft PC98/PC99, AC97 2.1
Mixed sound source	Line-in, CD, Video, AUX
Voice channel	8/16 bit, mono/stereo
Sampling rate	44.1 KHz
Internal microphone	Yes
Internal speaker / Quantity	Yes/ 2 pieces
Supports PnP DMA channel	DMA channel 0 DMA channel 1
Supports PnP IRQ	IRQ3, IRQ5, IRQ7, IRQ9, IRQ10, IRQ11

Video Interface

Item	Specification
Vendor & model name	ATI Rage Mobility-M1
Chip voltage	Core/2.5V Memory/3.3V
Supports ZV (Zoomed Video) port	Yes
Graph interface	2X AGP (Accelerated Graphics Port) bus
Maximum resolution (LCD)	1024x768 (24 bit colors)
Maximum resolution (CRT)	1024x768 (24 bit colors)

Video Memory

Item	Specification
Fixed or upgradeable	Fixed, built-in video controller
Video memory size	8.0 MB

Video Resolutions Mode

Resolution	Refresh Rate	
	CRT Only	LCD/CRT Simultaneous
640x480x256	85	60
640x480x64K	85	60
640x480x16M	85	60
800x600x256	85	60
800X600X64K	85	60
1024x768x256	60, 75	60

Parallel Port

Item	Specification
Parallel port controller	ALi M1535
Number of parallel port	1
Location	Rear side
Connector type	25-pin D-type connector, in female type
Parallel port function control	Enable/Disable by BIOS Setup
Supports ECP/EPP	Yes (set by BIOS Setup)
Optional ECP DMA channel (in BIOS Setup)	DMA channel 1 and 3
Optional parallel port I/O address (in BIOS Setup)	3BCh, 378h, 278h
Optional parallel port IRQ (in BIOS Setup)	IRQ5, IRQ7

Serial Port

Item	Specification
Serial port controller	ALi M1535
Number of serial port	1
Supports 16550 UART	Yes
Connector type	9-pin D-type connector, in male type
Location	Rear side
Serial port function control	Enable/Disable by BIOS Setup
Optional serial port (in BIOS Setup)	3F8h, 3E8h, 2E8h
Optional serial port IRQ (in BIOS Setup)	IRQ4, IRQ11

USB Port

Item	Specification
USB Compliancy Level	1.0
HCI	OHCI 1.0a
Number of USB port	2
Location	Rear side

IrDA Port

Item	Specification
IrDA FIR port controller	ALi M1535
Number of IrDA FIR port	1
Location	Left side
IrDA FIR port function control	Enable/disable by BIOS Setup
Optional IrDA FIR port (in BIOS Setup)	2F8h, 3F8h, 3E8h, 2E8h
Optional IrDA FIR port IRQ (in BIOS Setup)	IRQ3, IRQ4
Optional IrDA FIR port DRQ (in BIOS Setup)	DMA0, DMA1, DMA3

PCMCIA Port

Item	Specification
PCMCIA controller	O2 OZ6933
Supports card type	Type III/II/I
Number of slots	One type III or two type II/I
Access location	Left side
Supports ZV (Zoomed Video) port	Yes
Supports 32 bit CardBus	Yes (IRQ9)

Keyboard

Item	Specification
Keyboard controller	Mitsubishi M38867
Keyboard vendor & model name	JME K9811
Total number of keypads	84/85/88-key
Windows 95 keys	Yes
Internal & external keyboard work simultaneously	Yes

Battery

Item	Specification
Vendor & model name	Sanyo BTP-34A1
Battery Type	Li-Ion
Pack capacity	3600 mA·H
Cell voltage	3.7V
Number of battery cell	8
Package configuration	4S2P
Package voltage	14.8V

DC-DC/Charger Converter

Item	Specification
Vendor & Model Name	Acer
Input Voltage	AC Adapter or Battery: 10V - 26V

DC-DC/Charger Converter

Item	Specification			
DC-DC Converter Output				
Output Rating	5V	3.3V	12V	5V SB
Current (w/load, A)	0~4.5	0~3.5	0~0.12	0~0.02
Charger Output				
Normal charge (charge while system is not operative)	2.5A			
Background charge (charge even system is still operative)	1A			
Battery-low 2 level (V)	13.5V			
Battery-low 3 level (V)	None			
Protection				
Charger protection	Over Current Protection			
DC/DC converter protection	OCP (Over Current Protection, A) OVP (Over Voltage Protection, V) UVP (Under Voltage Protection, V)			

DC-AC LCD Inverter

Item	Specification
Vendor & model name	Ambit
Input voltage (V)	8 ~ 21V
Input current (mA)	1A (max.)
Output voltage (Vrms, no load)	1400Vrms
Output voltage frequency (kHz)	40 ~ 70KHz
Output Current/Lamp	5.5 mA ~ 6.5mA

NOTE: DC-AC inverter is used to generate very high AC voltage, then support to LCD CCFT backlight user, and is also responsible for the control of LCD brightness. Avoid touching the DC-AC inverter area while the system unit is turned on.

NOTE: There is an EEPROM in the inverter, which stores its supported LCD type and ID code. If you replace a new inverter or replace the LCD with a different brand, use Inverter ID utility to update the ID information.

LCD

Item	Specification			
Vendor & model name	12.1" Hitachi TX31D35VC1CAA	13.3" ADT L133X2-3	14.1" ADT L141X1-1	14.1" IBM ITXG76C
Mechanical Specifications				
LCD display area (diagonal, inch)	12.1	13.3	14.1	14.1
Display technology	TFT	TFT	TFT	TFT
Resolution	SVGA (800x600)	XGA (1024x768)	XGA (1024x768)	XGA (1024x768)
Support colors	16M	262K	262K	16M
Optical Specification				
Brightness control	Keyboard hot key	keyboard hotkey	Keyboard hotkey	Keyboard hot key
Contrast control	None	None	None	None
Electrical Specification				
Supply voltage for LCD display (V)	3.3 (typ.)	3.3 (typ.)	3.3 (typ.)	3.3 (typ.)

LCD

Item	Specification			
Supply voltage for LCD backlight (Vrms)	550 (typ.)	601 (typ.)	670 (typ.)	670 (typ.)

AC Adapter

Item	Specification	
Vendor & model name	Delta ADT-60XB D 3P	LiteOn PA-1600-02
Input Requirements		
Maximum input current	1.5A @ 90Vac 0.9A @ 180Vac	1.5A @ 90Vac 0.95A @ 180Vac
Nominal frequency (Hz)	47 - 63	47 - 63
Frequency variation range (Hz)	47 - 63	47 - 63
Nominal voltages (V)	90 - 270	90 - 270
Inrush current	The maximum inrush current will be less than 50A and 100A when the adapter is connected to 115Vac(60Hz) and 230Vac(50Hz) respectively	The maximum inrush current will be less than 50A and 100A when the adapter is connected to 115Vac(60Hz) and 230Vac(50Hz) respectively
Efficiency	It should provide an efficiency of 83% minimum, when measured at maximum load under 115V(60Hz)	It should provide an efficiency of 83% minimum, when measured at maximum load under 115V(60Hz)
Output Ratings (CV mode)		
DC output voltage	19V - 20.5V	19V - 20.5V
Noise + Ripple	300mVp-pmax (20MHz bandwidth)	300mVp-pmax (20MHz bandwidth)
Load	0 A (min.); 3.16 A (max.)	0 A (min.); 3.16 A (max.)
Output Ratings (CC mode)		
DC output voltage	+12V ~ +19V	+12V ~ +19V
Constant output	3.6 +/- 0.3	3.6 +/- 0.3
Dynamic Output Characteristics		
Turn-on delay time	2 sec (@ 115Vac)	2 sec (@ 115Vac)
Hold up time	8 ms (@115Vac input, full load)	8 ms (@115Vac input, full load)
Over Voltage Protection (OVP)	24V	24V
Short circuit protection	Output can be shorted without damage	Output can be shorted without damage
Electrostatic discharge (ESD)	15kV (at air discharge) 8kV (at contact discharge)	15kV (at air discharge) 8kV (at contact discharge)
Dielectric Withstand Voltage		
Primary to secondary	1500 Vac (or 2121 Vdc), 10mA for 1 second	
Leakage current	0.25 mA max. (@ 254 Vac, 60Hz)	
Regulatory Requirements	Internal Filter meets: 1. FCC class B requirements. (USA) 2. VDE 243/1991 class B requirements. (German) 3. CISPR 22 Class B requirements. (Scandinavia) 4. VCCI class II requirements. (Japan)	

Power Management

Power Saving Mode	Phenomenon
Standby Mode <ul style="list-style-type: none"> <input type="checkbox"/> Waiting time specified by the System Standby value or the operating system elapses without any system activity. <input type="checkbox"/> Closing the display cover <input type="checkbox"/> When the computer is about to enter Hibernation mode (e.g., during a battery-low condition), but the Hibernation file is invalid or not present. <input type="checkbox"/> When customized functions for power management are set to Standby and the corresponding action is taken. <input type="checkbox"/> Invoked by the operating system power-saving modes. 	<ul style="list-style-type: none"> <input type="checkbox"/> The buzzer beeps <input type="checkbox"/> The Sleep indicator lights up
Hibernation Mode <ul style="list-style-type: none"> <input type="checkbox"/> When customized functions for power management are set to Hibernation and the corresponding action is taken. <input type="checkbox"/> Invoked by the operating system power-saving modes. 	<ul style="list-style-type: none"> <input type="checkbox"/> All power shuts off
Display Standby Mode Keyboard, built-in touchpad, and an external PS/2 pointing device are idle for a specified period.	<ul style="list-style-type: none"> <input type="checkbox"/> The display shuts off
Hard Disk Standby Mode Hard disk is idle within a specified period of time.	<ul style="list-style-type: none"> <input type="checkbox"/> Hard disk drive is in standby mode. (spindle turned off)

Environmental Requirements

Item	Specification
Temperature	
Operating	+5 ~ +35°C
Non-operating	-10 ~ +60°C
Non-operating	-20 ~ +60°C (Storage package)
Humidity	
Operating	20% ~ 80% RH, non-condensing
Non-operating	20% ~ 80% RH, non-condensing
Non-operating	20% ~ 90% RH, non-condensing (storage package)
Vibration	
Operating (unpacked)	5 ~ 25.6 Hz: 0.38 mm (peak to peak) 25.6 ~ 250 Hz: 0.5G
Non-operating (unpacked)	5 ~ 27.1 Hz: 0.6G 27.1 Hz ~ 50 Hz: 0.4 mm (peak to peak) 50 ~ 500 Hz: 2.0G
Non-operating (packed)	5 ~ 62.6 Hz: 0.51 mm (peak to peak) 62.6 ~ 500 Hz: 4G

Mechanical Specifications

Item	Specification
Dimensions	310 (W) x 255 (D) x 36.6 (H) mm
Weight	6.1 lbs for 12.1" TFT 6.39 lbs for 14.1" TFT
I/O Ports	One type III or two type II/I PCMCIA (PC Card) port, two USB ports, one RJ-11 port, one RJ-45 port, one DC-in port, one expansion port, one parallel port, one serial port, one external display port, one PS/2 keyboard/mouse port, one FIR port, one line-in jack, one speaker/headphone-out jack, one microphone-in jack
Drive Bays	One
Material	Plastic
Indicators	Power-on, Standby, Battery Status, Media Access, Caps Lock and Num Lock
Switch	Power

Memory Address Map

Memory Address	Size	Function
00000000-0009FFFF	640 KB	Base memory
80600000-80600FFF	4 KB	Rage Mobility-M1 AGP
80620000-8063FFFF	128 KB	
81000000-81FFFFFF	3 MB	
000A0000-000CFFFF	192 KB	
000E0000-000ED7FF	54 KB	
80100000-80100FFF	4 KB	
80200000-802FFFFF	1 MB	
08000000-08000FFF	4 KB	O2 Micro OZ6933 Cardbus Controller
08001000-08001FFF	4 KB	
82400000-82400FFF	4 KB	USB
82200000-82200FFF	4 KB	Audio

I/O Address Map

I/O Address	Function
000-00F	DMA controller-1
020-021	Interrupt controller-1
040-043	Timer 1
060, 064	Keyboard controller 8742 chip select
061	System speaker
066	ACPI Embedded Controller
070-073	System CMOS/RTC
080	Main board resources
081-08F	DMA Controller-1
0A0-0A1	Interrupt controller-2
0C0-0DF	DMA controller-2
0F0-0FF	Numeric data processor
170-177/376	2nd EIDE device (CD-ROM) select
1F0-1F7/3F6	1st EIDE device (hard drive) select

I/O Address Map

I/O Address	Function
278-27F	Parallel port 3
2E8-2EF	Lucent Technologies Soft Modem AMR
2F8-2FF	ALi Fast Infrared Controller
378, 37F	Printer Port (LPT 1)
3B0-3BB, 3C0-3DF	Video Controller
3F0-3F5/3F7	Standard Floppy Disk Controller
3E8-3EF	COM3
3F8-3FF	COM1 or LT Win modem (optional)
480-48F, 4D6	DMA controller-1
4D0-4D1, CF8-CFF	PCI configuration register

IRQ Assignment Map

Interrupt Channel	Function
NMI	System errors
IRQ0	System timer
IRQ1	Keyboard
IRQ2	Cascade
IRQ3	IrDA
IRQ4	COM1
IRQ5	Reserved
IRQ6	Floppy
IRQ7	LPT1
IRQ8	Real time clock
IRQ9	SCI
IRQ10	Audio/Modem/LAN
IRQ11	USB/VGA/Cardbus
IRQ12	PS2 pointing device
IRQ13	Numeric data processor
IRQ14	1st IDE device (hard disk)
IRQ15	2nd EIDE device (CD-ROM drive)

DMA Channel Assignment

DMA Channel	Function
DRQ0	Not used
DRQ1	Not used
DRQ2	Floppy
DRQ3	FIR
DRQ4	DMA controller
DRQ5	Not used
DRQ6	Not used
DRQ7	Not used

System Utilities

BIOS Setup Utility

The BIOS Setup Utility is a hardware configuration program built into your computer's BIOS (Basic Input/Output System).

Your computer is already properly configured and optimized, and you do not need to run this utility. However, if you encounter configuration problems, you may need to run Setup. Please also refer to Chapter 4 Troubleshooting when problem arises.

To activate the BIOS Utility, press **F2** during POST (while the TravelMate logo is being displayed).

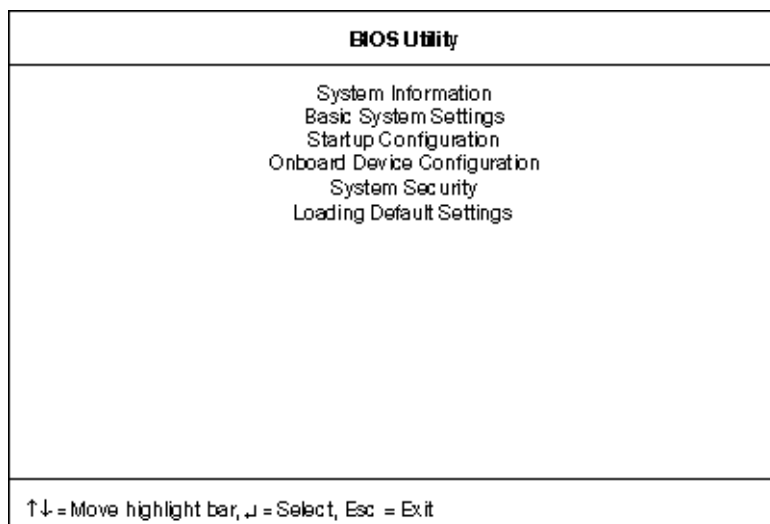

Navigating the BIOS Utility

There are six menu options: System Information, Basic System Settings, Startup Configuration, Onboard Device Configuration, System Security and Loading Default Settings.

To enter a menu, highlight the item using the **cursor up/down** keys, then press **Enter**.

Within a menu, navigate through the BIOS Utility by following these instructions:

- Press the **cursor up/down** keys to move between the parameters.
- Press the **cursor left/right** keys to change the value of a parameter.
- Press the **Esc** key while you are in any of the menu options to return to the main menu.

NOTE: You can change the value of a parameter if it is enclosed in square brackets. Navigation keys are shown at the bottom of the screen.

System Information

The System Information screen displays a summary of your computer hardware information.

System Information		Page 1/1
CPU Type & Speed -----	[Pentium III 500 Mhz]	
Floppy Disk Drive-----	[1.44 MB 3.5-inch]	
Hard Disk (MB) -----	[8845 MB]	
HDD Serial Number-----	[XXXXXXXXXXXXXXXXXXXXXXXXXX]	
System with-----	[CD-ROM Attached]	
System BIOS Version-----	[V8.0R01-A3C]	
VGA BIOS Version-----	[V8.0R01-A3C]	
Serial Number-----	[XXXXXXXXXXXXXXXXXXXXXXXXXX]	
Asset Tag Number-----	[XXXXXXXXXXXXXXXXXXXXXXXXXX]	
Product Name-----	[TravelMate 520 series]	
Manufacturer Name-----	[XXXXXXXXXXXXXXXXXXXX]	
UUID-----	[XXXXXXXX-XXXX-XXXX-XXXX-XXXXXXXXXX]	
↑↓ = Move highlight bar, ←→ = Change setting, F1 = Help		

NOTE: The screen above is a sample and may not reflect the actual data on your computer. “X” may refer to a series of numbers and/or characters.

The following table describes the information in this screen.

Parameter	Description
CPU Type & Speed	Describes the type of CPU installed in the system.
Floppy Disk Drive	Shows the floppy disk drive type (1.44 MB, 3.5-inch).
Hard Disk Drive	Shows the size or capacity of the hard disk.
HDD Serial Number	Shows the serial number of the hard disk.
System with	Shows the high-capacity disc drive installed.
System BIOS Version	Shows the system BIOS version.
VGA BIOS Version	Shows the video graphics accelerator BIOS version.
Serial Number	Shows the serial number of the computer.
Asset Tag Number	Shows the asset tag number of the computer.
Product Name	Shows the official name of the product.
Manufacturer Name	Shows the manufacturer of the computer.
UUID	Shows the universally unique identifier of your computer.

The items in this screen are important and vital information about your computer. If you experience computer problems and need to contact technical support, this data helps our service personnel know more about your computer.

Basic System Settings

The Basic System Settings screen allows you to set the system date and time.

Basic System Configuration		Page 1/1
Date-----	[Mon Nov. 06, 1999]	
Time-----	[12:00:00]	
↑↓ = Move highlight bar, ←→ = Change setting, F1 = Help		

The following table describes the parameters in this screen.

Parameter	Description	Format
Date	Sets the system date.	DDD MMM DD, YYYY (day-of-the-week month day, year)
Time	Sets the system time.	HH:MM:SS (hour:minute:second)

Startup Configuration

The Startup Configuration screen contains parameter values that define how your computer behaves on system startup.

Startup Configuration		Page 1/1
Boot Display -----	[Both]	
Screen Expansion -----	[Enabled]	
Resume on LAN/Modem Access -----	[Enabled]	
Hotkey Beep -----	[Enabled]	
Fast Boot -----	[Enabled]	
Boot Drive Sequence:		
1st. -----	[Floppy Disk]	
2nd. -----	[CD-ROM]	
3rd. -----	[Hard Disk]	
4th. -----	[LANDesk (R) Service Agent]	
↑↓ = Move highlight bar, ←→ = Change setting, F1 = Help		

The following table describes the parameters in this screen. Settings in **boldface** are the default and suggested parameter settings.

Parameter	Description	Options
Boot Display	Sets the display device on boot-up. When set to Auto , the computer automatically determines the display device when the computer starts up. If an external display device (e.g., monitor) is connected, it becomes the boot display; otherwise, the computer's display screen is the boot display. When set to Both , the computer outputs to both the computer display screen and an external display device if one is connected.	Both or Auto
Screen Expansion	When set to enabled, the screen will automatically adjust the display to fit the screen when the resolution is set to 640 x 480.	Enabled or Disabled
Resume on LAN/Modem Access	When enabled, it allows your computer to resume when LAN/Modem access is active.	Enabled or Disabled
Hotkey Beep	When enabled, the computer gives off a beep when a hotkey (key combination is pressed).	Enabled or Disabled
Fast Boot	Allows you to define your system's booting process; whether to skip some POST routines or proceed with the normal booting process.	Enabled or Disabled
Boot Drive Sequence	Specifies the order in which the computer starts up from. See the section below.	1st: Floppy Disk, 2nd: CD-ROM, 3rd: Hard Disk 4th: LANDesk (R) Service Agent

Setting the Boot Drive Sequence

The Boot Drive Sequence section lists boot priorities (1st, 2nd, 3rd and 4th) for bootable drives in your computer.

For example, the default value (1st:Floppy Disk, 2nd:CD-ROM, 3rd:Hard Disk and 4th:LANDesk (R) Service Agent) tells the computer to first search for a bootable floppy disk in the floppy drive. If it finds one present, it boots up from that floppy disk. If not, the computer continues to search for a bootable CD-ROM in the CD-ROM drive. If it cannot boot up from the CD-ROM drive, it continues by booting up from the hard disk.

To set the boot drive sequence, use the **cursor up/down keys** to select a priority level (1st, 2nd, 3rd and 4th), then use the **cursor left/right** keys to select the device for that priority level.

Onboard Device Configuration

The parameters in this screen are for advanced users only. You do not need to change the values in this screen because these values are already optimized.

The Onboard Device Configuration screen assigns resources to basic computer communication hardware.

Onboard Devices Configuration		Page 1/1
Serial Port -----	[Enabled]	
Base Address -----	[3F8h]	
IRQ -----	[4]	
IrDA FIR -----	[Disabled]	
Base Address -----	[-]	
IRQ -----	[-]	
DMA -----	[-]	
Parallel Port -----	[Enabled]	
Base Address -----	[378h]	
IRQ -----	[7]	
Operation Mode -----	[Bi-directional]	
ECP DMA Channel -----	[-]	
= Move highlight bar, = Change setting, F1 = Help		

The following table describes the parameters in this screen. Settings in **boldface** are the default and suggested parameter settings.

Parameter	Description	Options
Serial Port	Enables or disables the serial port. When enabled, you can set the base I/O address and interrupt request (IRQ) of the serial port.	Enabled or Disabled 3F8h , 3E8h, 2F8h or 2E8h 4 or 11
IrDA FIR Port	Enables or disables the infrared port. When enabled, you can set the base I/O address and interrupt request (IRQ) and direct memory access (DMA) channel of the infrared port.	Disabled or Enabled
Parallel Port	Enables or disables the parallel port. When enabled, you can set the base I/O address, interrupt request (IRQ) and operation mode of the parallel port. If operation mode is set to ECP, the direct memory access (DMA) channel of the parallel port is set to 1.	Enabled or Disabled 378h , 278h, or 3BCh 7 or 5 Bi-directional , ECP, EPP or Standard

System Security

The System Security screen contains parameters that help safeguard and protect your computer from unauthorized use.

System Security		Page 1/1
Setup Password -----	[None]	
Power-on Password -----	[None]	
Hard Disk Password -----	[None]	
Processor Serial Number -----	[Enabled]	
↑↓ = Move highlight bar, ←→ = Change setting, F1 = Help		

The following table describes the parameters in this screen. Settings in **boldface** are the default and suggested parameter settings.

Parameter	Description	Options
Setup Password	When set, this password protects the computer and the BIOS Utility from unauthorized entry. See the following section for instructions on how to set a password.	None or Present
Power-on Password	When set, this password protects the computer from unauthorized entry. See the following section for instructions on how to set a password.	None or Present
Hard Disk Password	When set, this password protects the hard disk from unauthorized access. See the following section for instructions on how to set a password.	None or Present
Processor Serial Number	The Pentium III processor includes a unique serial number which allows individual CPUs to be identified. You can turn off this feature by setting this parameter to Disabled. This one is not available in the model with Celeron processor.	Enabled or Disabled

Setting a Password

Follow these steps:

1. Use the cursor up/down keys to highlight a Password parameter (Setup, Power-on or Hard Disk) and press the **Enter** key. The password box appears:

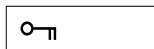

2. Type a password. The password may consist of up to eight characters (A-Z, a-z, 0-9).

IMPORTANT: Be very careful when typing your password because the characters do not appear on the screen.

3. Press **Enter**. Retype the password to verify your first entry and press **Enter**.
4. After setting the password, the computer automatically sets the chosen password parameter to Present.

Three password types protect your computer from unauthorized access. Setting these passwords creates several different levels of protection for your computer and data:

- ❑ Setup Password prevents unauthorized entry to the BIOS Utility. Once set, you must key-in this password to gain access to the BIOS Utility.
- ❑ Power-On Password secures your computer against unauthorized use. Combine the use of this password with password checkpoints on boot-up and resume from hibernation for maximum security.
- ❑ Hard Disk Password protects your data by preventing unauthorized access to your hard disk. Even if the hard disk is removed from the computer and moved to another computer, it cannot be accessed without the Hard Disk Password.

When a password is set, a password prompt appears on the left-hand corner of the display screen.

1. When the Setup Password is set, the following prompt appears when you press **F2** to enter the BIOS Utility at boot-up.

Setup Password

Type the Setup Password and press **Enter** to access the BIOS Utility.

2. When the Power-on Password is set, the following prompt appears at boot-up.



Type the Power-on Password (a symbol appears for each character you type) and press **Enter** to use the computer. If you enter the password incorrectly, an **x** symbol appears. Try again and press **Enter**.

3. When the Hard Disk Password is set, the following prompt appears at boot-up.



Type the Hard Disk Password (a symbol appears for each character you type) and press **Enter** to use the computer. If you enter the password incorrectly, an **x** symbol appears. Try again and press **Enter**.

You have three chances to enter a password. If you successfully entered the password, the following symbol appears.



If you fail to enter the password correctly after three tries, the following message or symbol appears.

Setup
Incorrect password specified. System disabled.

Power-on/Hard Disk



To change a password, follow the same steps used to set a password.

To remove a password, follow the same steps used to set a password, except type nothing in the password boxes.

Load Default Settings

If you want to restore all parameter settings to their default values, select this menu item and press **Enter**. The following dialog box displays.

Do you want to load default settings?

[Yes] [No]

If you would like to load default settings for all parameters, use the cursor **left/right** (**→←**) keys to select **Yes**; then press **Enter**. Choose **No** if otherwise.

BIOS Flash Utility

The BIOS flash memory update is required for the following conditions:

- New versions of system programs
- New features or options

Use the AFlash utility to update the system BIOS flash ROM.

NOTE: Do not install memory-related drivers (XMS, EMS, DPMS) when you use AFlash.

NOTE: This program contains a readme.txt file. This readme.txt file will introduce on how to use AFlash utility.

Executing Flash Program

IMPORTANT: If this diskette is not bootable, do the following actions before you use it:

1. Create a bootable disk.
2. Copy all AFlash files into this bootable diskette.
3. Put the bootable disk into TravelMate 520 series module, then reboot.

IMPORTANT: Never turn off the system power while Flash BIOS is programming. This will damage your system.

4. After Flash BIOS is done, reboot the system.

NOTE: If there are any problems occurred during BIOS update, see "Index of PQA Diagnostic Error Code, Message" on page 81 for troubleshooting.

System Utility Diskette

This utility diskette is for the Acer TravelMate 520 notebook machine. It provides the following functions:

1. Panel ID Utility
2. Thermal & Fan Utility
3. Main Board Data Utility

To use this diskette, first boot from this diskette, then a "Microsoft Windows 98 Startup Menu" prompt you to choose the testing item. Follow the instructions on screen to proceed.

NOTE: This program contains a readme.txt file. This readme.txt file will introduce each test utility and its functions.

IMPORTANT: If this diskette is not bootable, do the following actions before you use it:

1. Do system transfers.
2. Copy the following files to A:\.
HIMEM.SYS
RAMDRIVE.SYS

Panel ID Read/ Write Utility

1. Panel ID Read

This function will display the panel ID setting of Acer TravelMate 520 series, there maybe no values in inverter if no ID was found.

2. Panel ID Write

This function will display a table of all panel IDs of Acer TravelMate 520 series, and ask to input the no. corresponding to the panel ID of the LCD. Then, the chosen ID will be set in EEPROM.

Thermal test Utility

1. Read thermal setting

This function will show the current thermal setting of your system and CPU which include the status, current local temp, remote temp, conversion and configuration.

2. Set thermal setting

This function will write the default values into EEPROM.

3. Test fan

This function will test the fan.

Error message will be displayed when problem is found.

Main Board Data Utility

1. Read Main Board Data.

This function displays the MBD data.

2. Create MBD header, product & manufacturer names.

This function will create three informations and write to EEPROM automatically:

- a. Header information
- b. Product name
- c. Manufacturer name

3. Write MBD UUID

There are two sub-functions:

- a. Create and write a new UUID - this function is used when the original UUID is lost or damaged.

-
- b.** Write UUID by user keyin - this function is used when the original UUID is kept. User may use “Read Main Board Data” function first to keep the UUID.
 - 4.** Write MBD serial number - this function will write MBD serial number by user keyin.

System Diagnostic Diskette

IMPORTANT: ¹The diagnostics program here that we used is called PQA (Product Quality Assurance) and is provided by Acer Headquarters. You can utilize it as a basic diagnostic tool. To get this program, either download it from <http://csd.acer.com.tw> or find it in the TravelMate 520 service CD kit. To better fit local service requirements, your regional office MAY have other diagnostic program. Please contact your regional offices or the responsible personnel/channel to provide you with further technical details.

NOTE: This program contains a readme.txt file. This readme.txt file will introduce each test and its functions.

This diagnostic program is designed to perform the following diagnostic tools for Acer TravelMate 520 notebook machine. It provides the following functions.

1. PQA System Diagnostics
2. Audio Resource and Loopback Test
3. IR Test
4. USB Register and Connect/ Disconnect Test

To use this diskette, first boot from this diskette, then a "Microsoft Windows 98 Startup Menu" prompts you to choose the testing item. Follow the instructions on screen to proceed.

IMPORTANT: If this diskette is not bootable, do the following actions before you use it:

1. Do system transfers.
2. Copy the following files to A:\
HIMEM.SYS
RAMDRIVE.SYS
CHOICE.COM
MSCDEX.EXE

PQA System Diagnostics

NOTE: This PQA diagnostics program will test Acer TravelMate 520 notebook series' hardware peripherals.

1. When you select One Test, Test command (F2 key) will only work in the first-level menu (Item Test), if you are in sub-level menu, please press ESC to return to upper-level (Item Test) menu.
2. Use Space Bar to select/ deselect a testing item.
3. When testing is done, there will be a testing report, where you could find out whether the testing is successful or not.

Audio Resource and Speaker-Out Test

This function will test Audio Resource and Loopback of Acer TravelMate 520 notebook series. You will see "PASS" when test is successful.

You need "Loopbacker" when you choose "Loopback Test". Please put Loopbacker in Line-in, Line-out and Micro-in. You will see "PASS" when test is successful.

Infrared Ray (IR) Test

This function will test Infrared Ray of Acer TravelMate 520 series. Following are the steps:

1. You must prepare a reflect server (another Acer TravelMate 520 notebook) which can reply to testing unit the communicated data.
2. Prepare a bootable disk for the server, choose "Make a Host Disk".
3. Insert the Host disk in Host Server, then reboot.

¹ New added description. Please pay attention to it.

4. Type "Host" to run Host server first.
5. If there is no reflect server, the test program will show "IR FAIL".

USB Register and Connect/ Disconnect Test

This function will test USB Register and Connect/Disconnect of TravelMate 520 notebook series.

1. Register test (USBCMD, USBINTR, FRNNUM, FLBASEADD, SOF) - test its own USB internal circuit.
2. UHCI/ OHCI test utility
 - a. Please prepare a USB device such as USB mouse, USB keyboard or USB modem, and leave the USB port disconnected. (Don't connect first)
 - b. Program will dynamically detect the incoming device for two times, please plug the USB connector in USB port first, then plug it out. (Connect one time, disconnect one time)
 - c. The test program will show the account of connected/ disconnected, if every steps was doing right, the screen will show "PASS", otherwise show "FAIL".

Running PQA Diagnostics Program

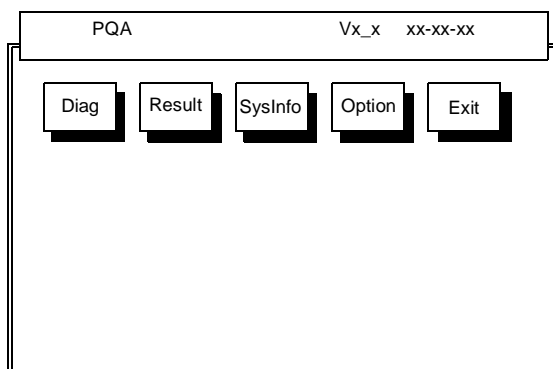

Press →← to move around the main menu. Press Enter to enable the selected option. The main options are Diag, Result, SysInfo, Option and Exit.

The Diag option lets you select testing items and times.

The following screen appears when you select Diag from the main menu.

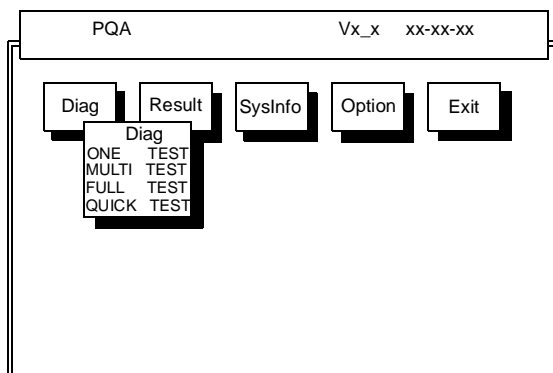

One Test performs a single test and Manual checks the selected test items in sequence.

Multi Test performs multiple tests of the selected items and check the selected test items in sequence.

Full Test performs all test items in detail for your system.

Quick Test performs all test items quickly for your system.

The screen below appears if you select Multi Test.

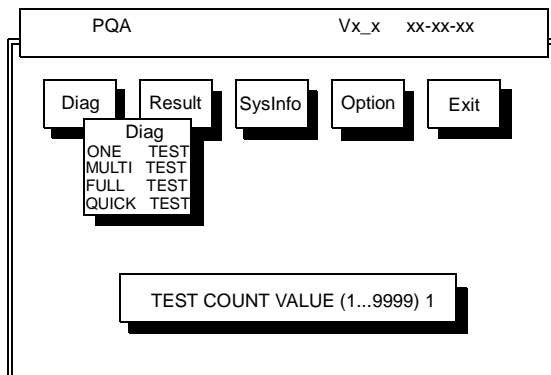

Specify the desired number of tests and press **Enter**.

After you specify the number of tests to perform, the screen shows a list of test items (see below).

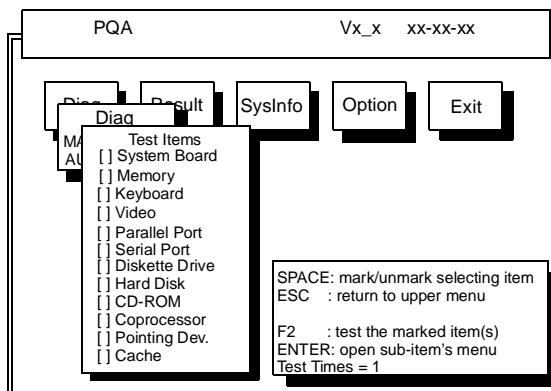

Move the highlight bar from one item to another. Press Space to enable or disable the item. Press **Enter** to view the available options of each selected item. Press **Esc** to close the submenu.

The right corner screen information gives you the available function keys and the specified test number.

- Space: Enables/disables the item
- ESC: Exits the program
- F1: Help
- F2: Tests the selected item(s)
- Enter: Opens the available options
- Test Times: Indicates the number of tests to perform.

NOTE: The F1 and F2 keys function only after you finish configuring the Test option.

NOTE: When any errors are detected by diagnostic program, refer to "Index of PQA Diagnostic Error Code, Message" on page 81 for troubleshooting.

Machine Disassembly and Replacement

This chapter contains step-by-step procedures on how to disassemble the notebook computer for maintenance and troubleshooting.

To disassemble the computer, you need the following tools:

- Wrist grounding strap and conductive mat for preventing electrostatic discharge
- Flat-bladed screw driver
- Phillips screw driver
- Tweezers
- Flat-bladed screw driver or plastic stick

NOTE: The screws for the different components vary in size. During the disassembly process, group the screws with the corresponding components to avoid mismatch when putting back the components.

General Information

Before You Begin

Before proceeding with the disassembly procedure, make sure that you do the following:

1. Turn off the power to the system and all peripherals.
2. Unplug the AC adapter and all power and signal cables from the system.

Disassembly Procedure Flowchart

The flowchart on the succeeding page gives you a graphic representation on the entire disassembly sequence and instructs you on the components that need to be removed during servicing. For example, if you want to remove the system board, you must first remove the keyboard, then disassemble the inside assembly frame in that order.

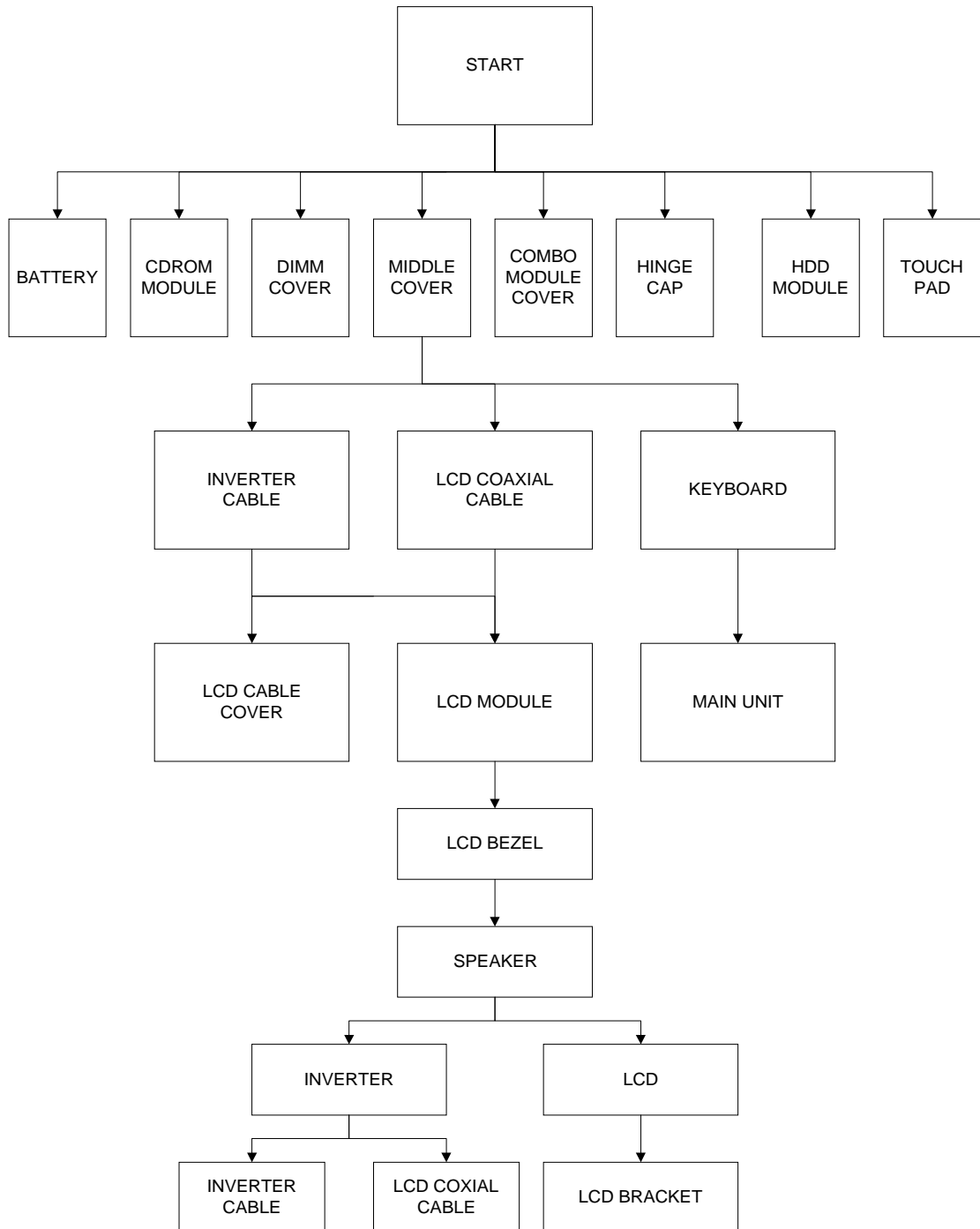

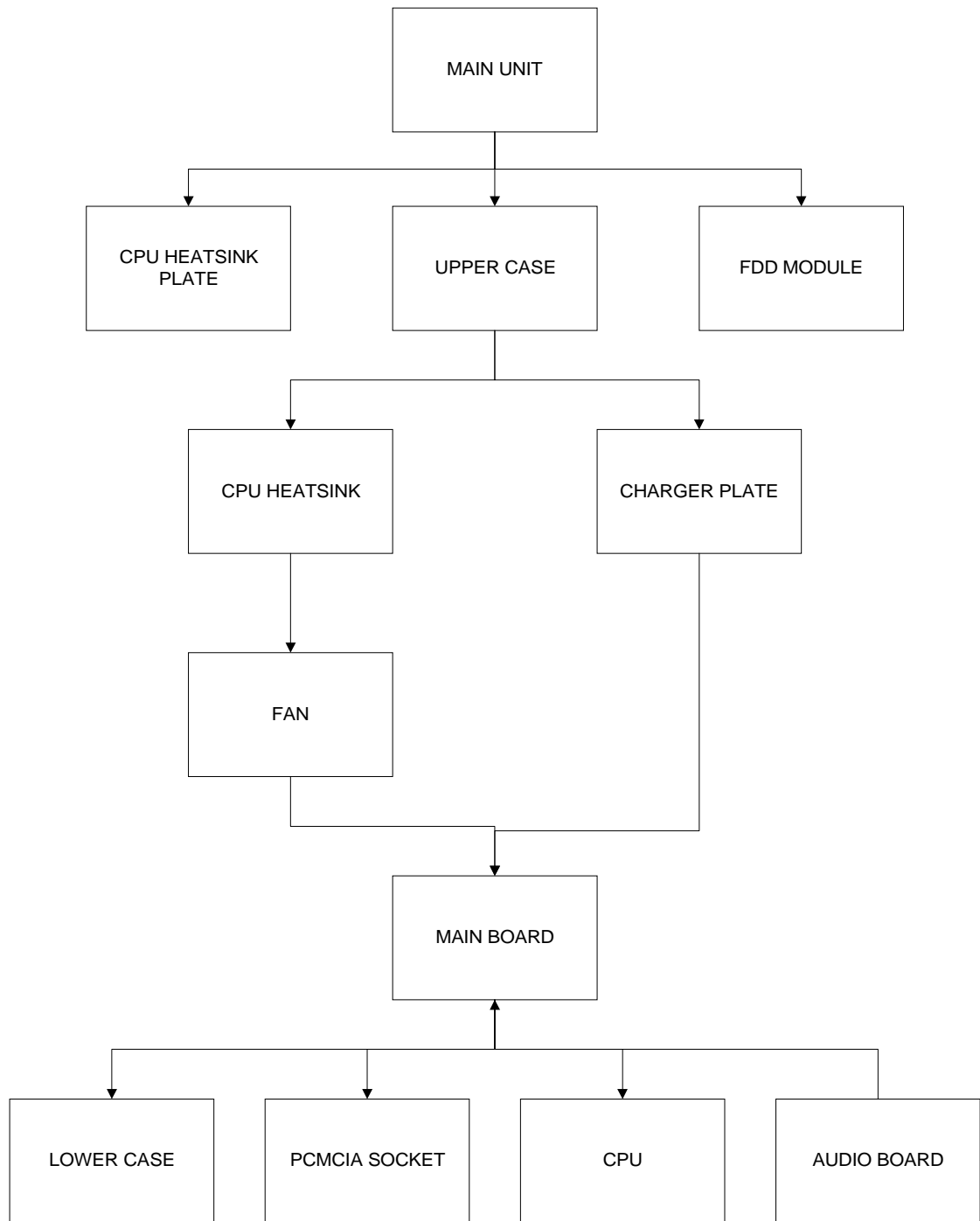

Removing the Battery Pack

1. To remove the battery pack, push the battery release button inward.
2. Slide the battery pack out from the machine.

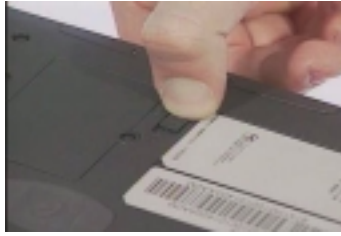

Removing the Battery Cover

1. To remove the battery cover, press the cover on this side outward carefully, then remove the cover.



Removing the CD-ROM Drive Module

1. To remove the CD-ROM drive module, push the release button outward.
2. Slide it out from the machine.



Disassembling the CD-ROM Drive Module

1. To disassemble the CD-ROM drive module, first remove the four screws as shown.
2. Remove the CD-ROM drive module from the CD-ROM drive chassis.

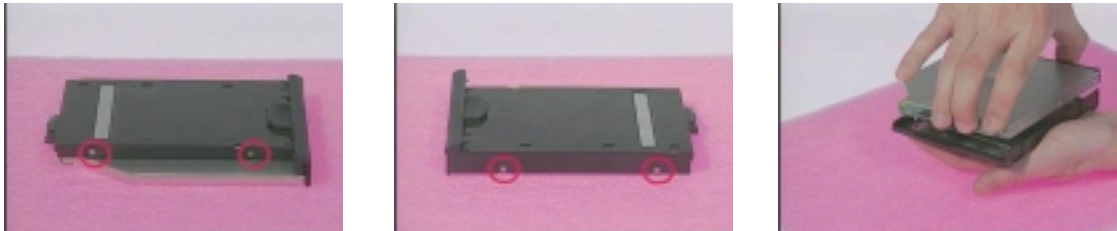

3. Remove the two screws from the CD-ROM board, then remove the CD-ROM board from the CD-ROM drive.

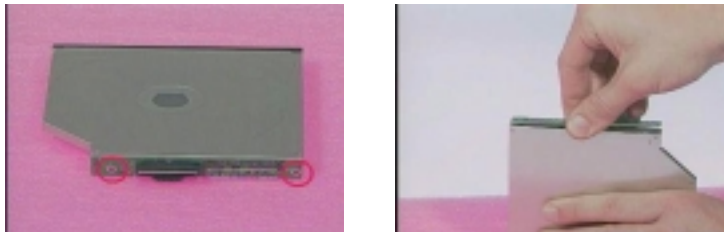

Removing the Hard Disk Drive Module

1. To remove the hard disk drive, first remove the hard disk drive cover screw, then remove the cover.

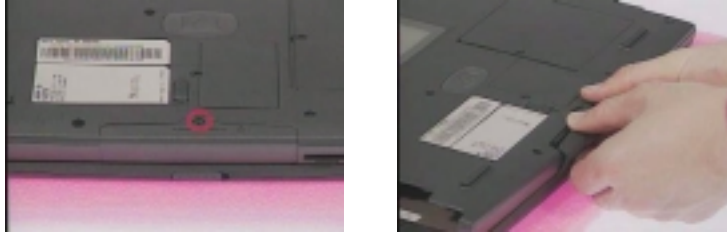

2. Remove the hard disk drive module out from the machine carefully.



Disassembling the Hard Disk Drive Module

1. To disassemble the hard disk drive module, first remove the two screws from the hard disk drive bracket.
2. Slide the hard disk drive out from the hard disk drive bracket.



3. Remove the hard disk drive connector from the hard disk drive.



Removing the Extended Memory

1. To remove an extended memory from the machine, first remove the screw from the memory cover.
2. Push the memory cover leftward to lift the cover off, then remove the memory cover.



3. Push out the latches on both sides of the socket, and pull the memory module out from the socket.



Removing the Modem Board

1. To remove the modem board, first remove the screw from the modem cover.
2. Remove the modem cover from the machine.



3. Remove the two screws from the modem board as shown, use a plastic bladed screwdriver to remove the modem board from the main unit.



4. At CN26, disconnect the modem cable from the modem board, then remove the modem board.



Disassembling the LCD

Removing the Hinge Cap

1. To remove the hinge cap, push the hinge cap outward, then slide the hinge cap out from the main unit.



Removing the Middle Cover

1. To remove the middle cover, push the middle cover rightward and lift the middle cover away.
2. Disconnect the launch board cable from the launch board.

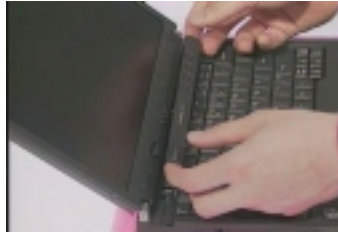
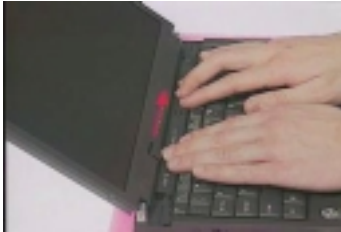

3. Remove the two screws from the launch board as shown, then remove the launch board from the middle cover.



Removing the Keyboard

1. To remove the keyboard, pull out and upward to expose the keyboard.

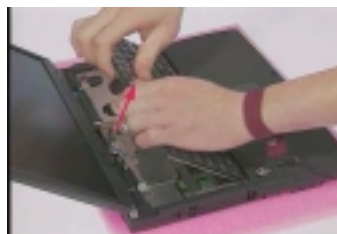

2. At CNX2, disconnect the keyboard cable from the main board carefully, then remove the keyboard from the main board.

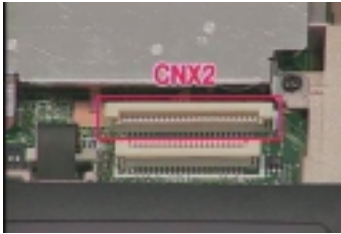

3. At CN10, disconnect the launch board cable from the main board, then remove it.



Removing the Cable Cover

1. To remove the cable cover, push the cable cover backward then pull the cover off gently.

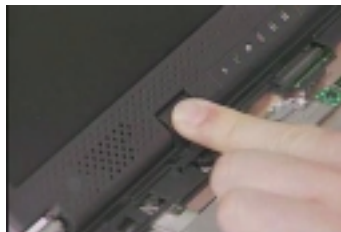

Removing the LCD Module

1. To remove the LCD module, first remove the two screws from the rear of the unit and the two screws from the base of the unit as shown.



- At CN9, remove the two screws from the LCD FPC cable, and then disconnect the LCD FPC cable from the main board.



- At CN8, disconnect the inverter cable from the main board.

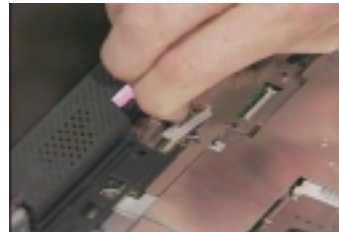

- Remove the LCD module from the main unit.
- Remove the video capture kit cover from the LCD module on each side.



- Remove the three LCD cushions as shown, next remove the three screws from the LCD bezel.



NOTE: If you have 12.1" or 13.3" LCD, you need to remove five LCD cushions and five screws.

-
7. Snap off the LCD bezel carefully, then remove the LCD bezel from the LCD module.



Removing the Inverter Board

1. To remove the inverter board, remove the two screws from the inverter board as shown.

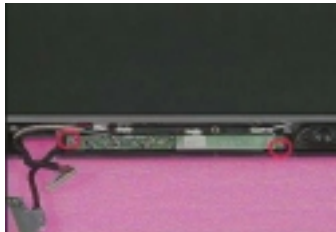

2. Disconnect the speaker cables, microphone cable and LCD power cable from the inverter board, then remove the inverter board.



3. Disconnect the inverter cable from the inverter board.

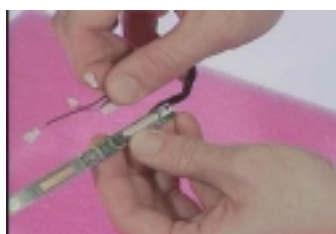

Removing the Speakers

1. Remove the two screws from the speakers as shown, then remove the speakers from the LCD module..



2. Remove the four screws from the LCD, then detach the LCD diaper from the LCD.

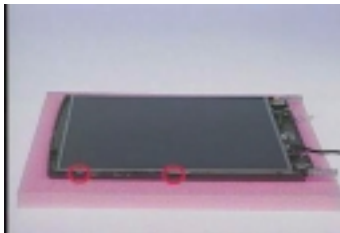

3. Remove the LCD from the LCD panel.

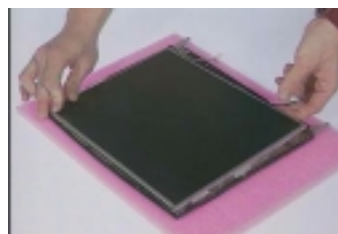

4. Remove the ESD tape, then disconnect the LCD FPC cable from the LCD.

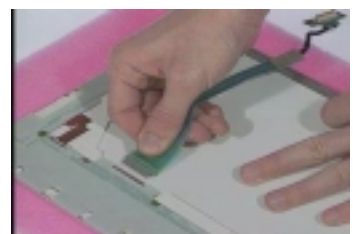
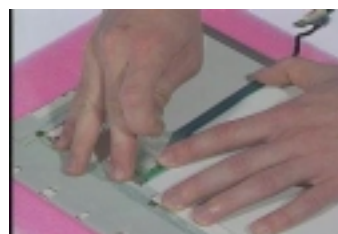
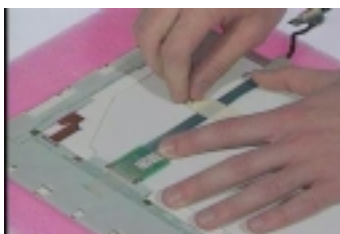

Removing the Microphone

1. Remove the microphone from the LCD.



Disassembling the Upper Case

Removing the Floppy Disk Drive Module

1. To remove the floppy disk drive module, first remove the screw from the upper case.



2. At CNX1, disconnect the floppy disk drive cable from the main unit, then pull the floppy disk drive module out from the main unit carefully.

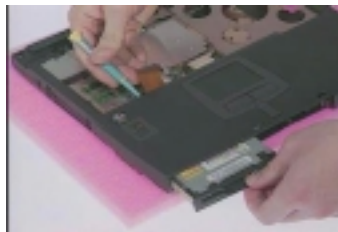

Disassembling the Floppy Disk Drive Module

1. To disassemble the floppy disk drive module, remove the two screws from the floppy disk drive bracket.
2. Remove the bracket from the drive.



3. Disconnect the floppy disk drive FPC cable from the drive.

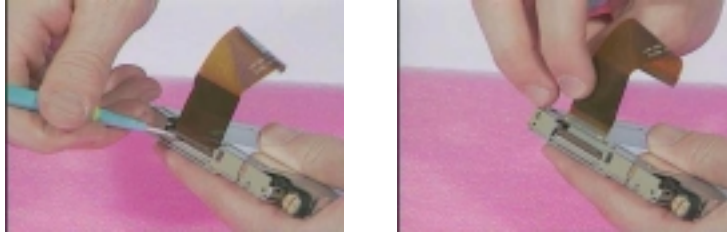

4. To remove the floppy disk drive bezel, remove the cushion from the drive, and then detach the bezel from the drive carefully.



Removing the CPU Heatsink Plate

1. Remove the two screws from the CPU heatsink plate, then pull the CPU heatsink plate backward then rightward from the main unit.



Removing the RTC Battery

1. Use the flat bladed screwdriver to remove the RTC battery gently.



2. Reinstall the RTC battery back into position by pressing it down to secure.



Removing the Upper Case

1. To remove the upper case, remove the eight screws from the base of the unit as shown.
2. At CN16, disconnect the touchpad cable from the main board.

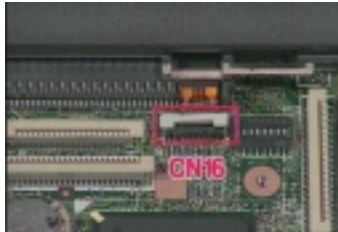

3. Pull the upper case up from rear to front of the unit gently.



4. Remove the touchpad frame from the upper case carefully.
5. Remove the touchpad scroll button from the upper case.

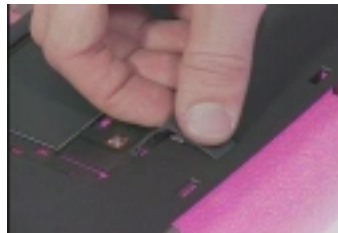

-
6. Disconnect the touchpad cable from the touchpad board, then remove the touchpad board from the upper case.



7. Remove the touchpad cable from the upper case carefully.



Disassembling the Lower Case

Removing the CPU Heatsink

1. Remove the four screws from the CPU heatsink.
2. Remove the CPU heatsink from the main unit.

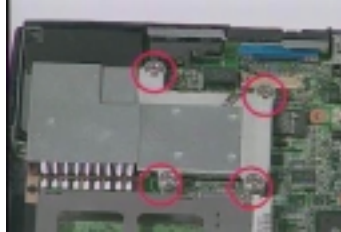

Removing the CPU

1. To remove the CPU, use a flat bladed screwdriver to release the screw carefully, then remove the CPU from the CPU socket.



Removing the Charger Plate

1. Remove the screw from the charger plate, then remove the charger plate from the main board.

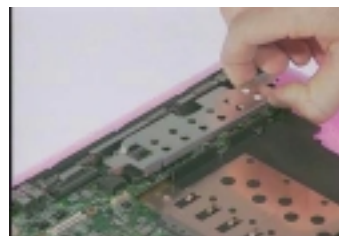
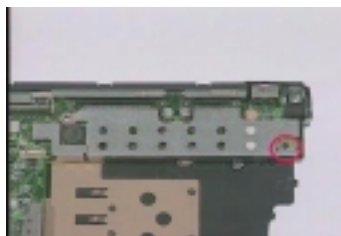

Removing the Main Board

1. Remove the three screws from the main board as shown.

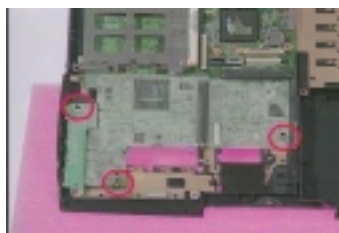

-
2. At CN11, disconnect the fan cable from the main board.



3. Pull the battery connector and audio jack out to remove the main board from the lower case.

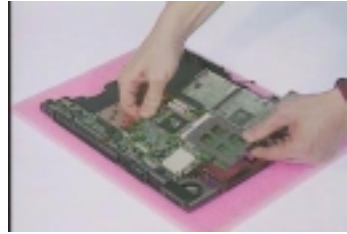

Removing the Fan

1. Remove the screw from the fan, then remove the fan from the lower case.

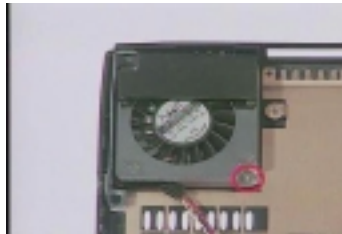

2. Detach the audio board from the main board.



Removing the PCMCIA Slot

1. Remove the two screws from the PCMCIA plate to remove the plate.

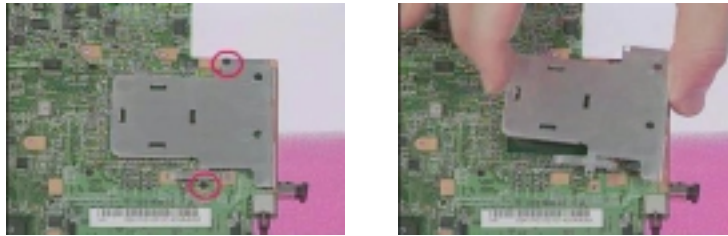

2. At CN13, remove the two screws from the PCMCIA slot, then detach the PCMCIA slot from the main board by hand gently.



Removing the I/O Bracket

1. Remove the six hexed screws and the two screws from the I/O bracket.



2. Remove the I/O bracket from the main board.



Removing the Modem Cable

1. At CN21 and CN22, disconnect the modem cable from the main board, then remove the modem cable from the main board.

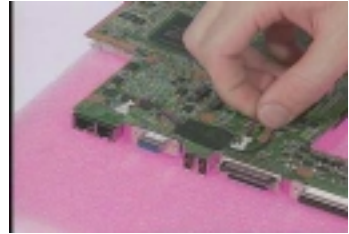

Troubleshooting

Use the following procedure as a guide for computer problems.

NOTE: The diagnostic tests are intended to test only Acer products. Non-Acer products, prototype cards, or modified options can give false errors and invalid system responses.

1. Obtain the failing symptoms in as much detail as possible.
2. Verify the symptoms by attempting to re-create the failure by running the diagnostic test or by repeating the same operation.
3. Use the following table with the verified symptom to determine which page to go to.

Symptoms (Verified)	Go To
Power failure. (The power indicator does not go on or stay on.)	Power System check
POST does not complete. No beep or error codes are indicated.	Symptom-to-FRU Index Undetermined Problems
POST detects an error and displayed messages on screen.	Error Messages List
The diagnostic test detected an error and displayed a FRU code.	Running PQA Diagnostic Program
Other symptoms (i.e. LCD display problems or others).	Error Symptom-to-FRU Index
Symptoms cannot be re-created (intermittent problems).	Use the customer-reported symptoms and go to Error Symptom-to-FRU Index. Intermittent Problems Undetermined Problems

System Check Procedures

Diskette Drive Check

Do the following to isolate the problem to a controller, driver, cable or diskette. A write-enabled, diagnostic diskette is required.

NOTE: Make sure that the diskette does not have more than one label attached to it. Multiple labels can cause damage to the drive or cause the drive to fail.

Do the following to select the test device.

1. Boot from the diagnostics diskette and start the PQA program.
2. Go to the diagnostic Diskette Drive in the test items.
3. Press F2 in the test items.
4. Follow the instructions in the message window.

If an error occurs with the internal diskette drive, reconnect the diskette connector on the system board.

If the error still remains:

1. Reconnect the diskette drive.
2. Replace the diskette driver cable.
3. Replace the diskette drive.
4. Replace the system board.

CD-ROM Drive Check

Do the following to isolate the problem to a controller, drive, cable, or CD-ROM. Make sure that the CD-ROM does not have any label attached to it. The label can cause damage to the drive or can cause the drive to fail.

Do the following to select the test device:

1. Boot from the diagnostics diskette and start the PQA program.
2. Go to the diagnostic CD-ROM in the test items.
3. Press F2 in the test items.
4. Follow the instructions in the message window.

If an error occurs, reconnect the connector on the System board. If the error still remains:

1. Reconnect the CD-ROM drive.
2. Replace the diskette driver cable.
3. Replace the CD-ROM drive.
4. Replace the system board.

Keyboard or Auxiliary Input Device Check

Remove the external keyboard if the internal keyboard is to be tested.

If the internal keyboard does not work or an unexpected character appears, make sure that the flexible cable extending from the keyboard is correctly seated in the connector on the system board.

If the keyboard cable connection is correct, run the Keyboard Test. See "Running the Diagnostics" for details.

If the tests detect a keyboard problem, do the following one at a time to correct the problem. (Do not replace a non-defective FRU):

1. Reconnect the keyboard cables.
2. Replace the keyboard.
3. Replace the system board.

The following auxiliary input devices are supported by this computer:

- Numeric keypad
- External keyboard

If any of these devices do not work, reconnect the cable connector and repeat the failing operation.

Memory Check

Memory errors might stop system operations, show error messages on the screen, or hang the system.

1. Boot from the diagnostics diskette and start the PQA program (please refer to “Running PQA Diagnostics Program”).
2. Go to the diagnostic memory in the test items.
3. Press F2 in the test items.
4. Follow the instructions in the message window.

NOTE: Make sure that the DIMM is fully installed into the connector. A loose connection can cause an error.

Power System Check

To verify the symptom of the problem, power on the computer using each of the following power sources:

1. Remove the battery pack.
2. Connect the power adapter and check that power is supplied.
3. Disconnect the power adapter and install the charged battery pack; then check that power is supplied by the battery pack.

If you suspect a power problem, see the appropriate power supply check in the following list:

- “Check the Power Adapter”
- “Check the Battery Pack”

Check the Power Adapter

Unplug the power adapter cable from the computer and measure the output voltage at the plug of the power adapter cable. See the following figure

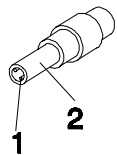

Pin 1: +19 to +20.5V
Pin 2: 0V, Ground

1. If the voltage is not correct, replace the power adapter.
2. If the voltage is within the range, do the following:
 - Replace the System board.
 - If the problem is not corrected, see “Undetermined Problems”.
 - If the voltage is not correct, go to the next step.

NOTE: An audible noise from the power adapter does not always indicate a defect.

3. If the power problem occurs only when the port replicator is used, replace the port replicator.
4. If the power-on indicator does not light up, check the power cord of the power adapter for correct continuity and installation.
5. If the operational charge does not work, see “Check the Battery Pack”.

Check the Battery Pack

To check the battery pack, do the following:

1. Power off the computer.
2. Remove the battery pack and measure the voltage between battery terminals 1(+) and 7(ground). See the following figure

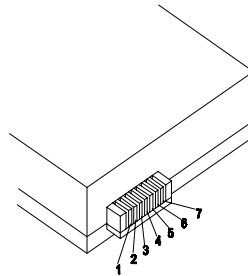

3. If the voltage is still less than 8.0 Vdc after recharging, replace the battery.

To check the battery charge operation, use a discharged battery pack or a battery pack that has less than 50% of the total power remaining when installed in the computer.

If the battery status indicator does not light up, remove the battery pack and let it return to room temperature. Re-install the battery pack.

If the charge indicator still does not light up, replace the battery pack. If the charge indicator still does not light up, replace the system board.

Touchpad Check

If the touchpad doesn't work, do the following actions one at a time to correct the problem. Do not replace a non-defective FRU:

1. Reconnect the touchpad cables.
2. Replace the touchpad cables.
3. Replace the touchpad.
4. Replace the system board.

After you use the touchpad, the pointer drifts on the screen for a short time. This self-acting pointer movement can occur when a slight, steady pressure is applied to the touchpad pointer. This symptom is not a hardware problem. No service actions are necessary if the pointer movement stops in a short period of time.

Index of Error Message

The symptom-to-FRU index lists the symptoms and errors and their possible causes. The most likely cause is listed first.

NOTE: Perform the FRU replacement or actions in the sequence shown in FRU/Action column, if the FRU replacement does not solve the problem, put the original part back in the computer. Do not replace a non-defective FRU.

This index can also help you determine the next possible FRU to be replaced when servicing a computer.

If the symptom is not listed, “Undetermined Problems” on page 79.

The following lists the error messages that the BIOS displays on the screen and the error symptoms classified by function.

NOTE: Most of the error messages occur during POST. Some of them display information about a hardware device, e.g., the amount of memory installed. Others may indicate a problem with a device, such as the way it has been configured.

NOTE: If the system fails after you make changes in the BIOS Setup Utility menus, reset the computer, enter Setup and install Setup defaults or correct the error

Error Messages List

Error Messages	Action in Sequence
Failure Fixed Disk	Reconnect hard disk drive connector. “Load Default Settings” in BIOS Setup Utility. Hard disk drive System board
Stuck Key	“Keyboard or Auxiliary Input Device Check” .
Keyboard error	“Keyboard or Auxiliary Input Device Check”.
Keyboard Controller Failed	“Keyboard or Auxiliary Input Device Check”.
Keyboard locked - Unlock key switch	Unlock external keyboard.
Monitor type does not match CMOS - Run Setup	Run “Load Default Settings” in BIOS Setup Utility.
Shadow RAM Failed at offset: nnnn	BIOS ROM System board
System RAM Failed at offset: nnnn	DIMM System board
Extended RAM Failed at offset: nnnn	DIMM System board
System battery is dead - Replace and run Setup	Replace RTC battery and Run BIOS Setup Utility to reconfigure system time, then reboot system.
System CMOS checksum bad - Default configuration used	RTC battery Run BIOS Setup Utility to reconfigure system time, then reboot system.
System timer error	RTC battery Run BIOS Setup Utility to reconfigure system time, then reboot system. System board
Real time clock error	RTC battery Run BIOS Setup Utility to reconfigure system time, then reboot system. System board
Previous boot incomplete - Default configuration used	Run “Load Default Settings” in BIOS Setup Utility. RTC battery System board

Error Messages List

Error Messages	Action in Sequence
Memory size found by POST differed from CMOS	Run "Load Default Settings" in BIOS Setup Utility. DIMM System board
Diskette drive A error	Check that the drive is defined with the proper diskette type in BIOS Setup Utility. Diskette Drive Check.
Incorrect Drive A type - run SETUP	Check that the drive is defined with the proper diskette type in BIOS Setup Utility Diskette Drive Check.
System cache error - Cache disabled	CPU board System board
CPU ID	CPU board System board
DMA Test Failed	DIMM CPU board System board
Software NMI Failed	DIMM CPU board System board
Fail-Safe Timer NMI Failed	DIMM CPU board System board
Device Address Conflict	Run "Load Default Settings" in BIOS Setup Utility. RTC battery System board
Allocation Error for device	Run "Load Default Settings" in BIOS Setup Utility. RTC battery System board
Failing Bits: nnnn	DIMM BIOS ROM System board
Fixed Disk n	None
Invalid System Configuration Data	BIOS ROM System board
I/O device IRQ conflict	Run "Load Default Settings" in BIOS Setup Utility. RTC battery System board
Operating system not found	Enter Setup and see if fixed disk and drive A are properly identified. Diskette drive Hard disk drive System board

No-Beep Symptoms

Symptom / Error	Action in Sequence
No beep, power-on indicator turns off and LCD is blank.	Power source (battery pack and power adapter). Power System Check. Ensure every connector is connected tightly and correctly. Reconnect the DIMM. CPU board System board.
No beep, power-on indicator turns on and LCD is blank.	Power source (battery pack and power adapter). Power System Check. Reconnect the LCD connectors Hard disk drive LCD inverter ID LCD cable Inverter LCD System board
No beep, power-on indicator turns on and LCD is blank. But you can see POST on an external CRT.	Reconnect the LCD connectors. LCD inverter ID LCD cable LCD inverter LCD System board
No beep, power-on indicator turns on and a blinking cursor shown on LCD during POST.	Ensure every connector is connected tightly and correctly. System board
No beep during POST but system runs correctly.	Speaker Audio board System board

Index of Symptom-to-FRU Error Message

LCD-Related Symptoms

Symptom / Error	Action in Sequence
LCD backlight doesn't work LCD is too dark LCD brightness cannot be adjusted LCD contrast cannot be adjusted	Enter BIOS Utility to execute "Load Setup Default Settings", then reboot system. Reconnect the LCD connectors. Keyboard (if contrast and brightness function key doesn't work). LCD inverter ID LCD cable LCD inverter LCD System board
Unreadable LCD screen Missing pixels in characters Abnormal screen Wrong color displayed	Reconnect the LCD connectors. LCD inverter ID LCD cable LCD inverter LCD System board
LCD has extra horizontal or vertical lines displayed.	LCD inverter ID LCD inverter LCD cable LCD System board

Indicator-Related Symptoms

Symptom / Error	Action in Sequence
Indicator incorrectly remains off or on, but system runs correctly.	Reconnect the LED board LED board System board

Power-Related Symptoms

Symptom / Error	Action in Sequence
Power shuts down during operation.	Power source (battery pack and power adapter). Power System Check. Battery pack Power adapter Audio board System board
The system doesn't power-on.	Power source (battery pack and power adapter). Power System Check. Battery pack Power adapter Audio board System board
The system doesn't power-off.	Power source (battery pack and power adapter). Power System Check. Hold and press the power switch for more than 4 seconds. System board

Power-Related Symptoms

Symptom / Error	Action in Sequence
Battery can't be charged	Power System Check Battery pack System board

PCMCIA-Related Symptoms

Symptom / Error	Action in Sequence
System cannot detect the PC Card (PCMCIA)	PCMCIA slot assembly System board
PCMCIA slot pin is damaged.	PCMCIA slot assembly

Memory-Related Symptoms

Symptom / Error	Action in Sequence
Memory count (size) appears different from actual size.	Enter BIOS Setup Utility to execute "Load Default Settings, then reboot system. DIMM System board

Speaker-Related Symptoms

Symptom / Error	Action in Sequence
In DOS or Windows, multimedia programs, no sound comes from the computer.	Press Fn-F8, Speaker ON/OFF control. Audio driver Speaker Audio board System board
Internal speakers make noise or emit no sound.	Press Fn-F8, Speaker ON/OFF control. Speaker Audio board System board

Power Management-Related Symptoms

Symptom / Error	Action in Sequence
The system will not enter hibernation	Keyboard (if control is from the keyboard) Hard disk drive System board Check with Sleep Manager.
The system doesn't enter hibernation mode and four short beeps every minute.	Hibernation Mode Press Fn+F4 and see if the computer enters hibernation mode. Touchpad Keyboard Hard disk connection board Hard disk drive System board
The system doesn't enter standby mode after closing the LCD	Standby Mode LCD cover switch System board
The system doesn't resume from hibernation mode.	Hibernation Mode Hard disk connection board Hard disk drive System board

Power Management-Related Symptoms

Symptom / Error	Action in Sequence
The system doesn't resume from standby mode after opening the LCD.	Standby Mode LCD cover switch System board
Battery fuel gauge in Windows doesn't go higher than 90%.	Remove battery pack and let it cool for 2 hours. Refresh battery (continue to use battery until power off, then charge battery). Battery pack Charger board System board
System hangs intermittently.	Set Thermal Sensor Threshold. Reconnect hard disk/CD-ROM drives. Hard disk connection board System board

Peripheral-Related Symptoms

Symptom / Error	Action in Sequence
System configuration does not match the installed devices.	Enter BIOS Setup Utility to execute "Load Default Settings", then reboot system. Reconnect hard disk/CD-ROM/diskette drives.
External display does not work correctly.	Press Fn+F5, LCD/CRT/Both display switching Running PQA Diagnostics Program. System board
USB does not work correctly.	System Diagnostics Diskette System board
Print problems.	Ensure that the "Parallel Port" in the "Onboard Devices Configuration" of BIOS Setup Utility is set to Enabled. Onboard Devices Configuration Run printer self-test. Printer driver Printer cable Printer System Board
Serial or parallel port device problems.	Ensure that the "Serial Port" in the "Onboard Devices Configuration" of BIOS Setup Utility is set to Enabled. Device driver Device cable Device System board

Keyboard/Touchpad-Related Symptoms

Symptom / Error	Action in Sequence
Keyboard (one or more keys) does not work.	Reconnect the keyboard cable. Keyboard System board
Touchpad does not work.	Reconnect touchpad cable. Touchpad board System board

Modem-Related Symptoms

Symptom / Error	Action in Sequence
Internal modem does not work correctly.	System Diagnostics Diskette Modem phone jack Modem board System board

NOTE: If you cannot find a symptom or an error in this list and the problem remains, see "Undetermined Problems" on page 79.

Intermittent Problems

Intermittent system hang problems can be caused by a variety of reasons that have nothing to do with a hardware defect, such as: cosmic radiation, electrostatic discharge, or software errors. FRU replacement should be considered only when a recurring problem exists.

When analyzing an intermittent problem, do the following:

1. Run the advanced diagnostic test for the system board in loop mode at least 10 times.
2. If no error is detected, do not replace any FRU.
3. If any error is detected, replace the FRU. Rerun the test to verify that there are no more errors.

Undetermined Problems

The diagnostic problems does not identify which adapter or device failed, which installed devices are incorrect, whether a short circuit is suspected, or whether the system is inoperative.

Follow these procedures to isolate the failing FRU (do not isolate non-defective FRU).

NOTE: Verify that all attached devices are supported by the computer.

NOTE: Verify that the power supply being used at the time of the failure is operating correctly.

1. Power-off the computer.
2. Visually check them for damage. If any problems are found, replace the FRU.
3. Remove or disconnect all of the following devices:
 - Non-Acer devices
 - Devices attached to the port replicator
 - Printer, mouse, and other external devices
 - Battery pack
 - Hard disk drive
 - DIMM
 - CD-ROM
 - Diskette drive
 - PC Cards
4. Power-on the computer.
5. Determine if the problem has changed.
6. If the problem does not recur, reconnect the removed devices one at a time until you find the failing FRU.
7. If the problem remains, replace the following FRU one at a time. Do not replace a non-defective FRU:
 - System board
 - LCD assembly

Index of AFlash BIOS Error Message

Error Message	Action in Sequence
Hardware Error	See "System Diagnostic Diskette" on page 40
BIOS Update Program Error	Turn off the power and restart the system.
System Error	Make sure this AFlash BIOS diskette for this model.
Without AC adapter	make sure to connect AC adapter
Battery Low	make sure to install a highly charged battery, and reboot system.

Index of PQA Diagnostic Error Code, Message

Error Code	Message	Action in Sequence
16XXX	Backup battery error	Backup battery
01XXX	CPU or main board error	Reload BIOS default setting. System board
02XXX	Memory error	DIMM System board
03XXX	Keyboard error	Reset Keyboard Keyboard System board
04XXX	Video error	System board
05XXX	Parallel Port error	System board
06XXX	Serial port or main board error	System board
07XXX	Diskette drive error	Diskette drive System board
08XXX	Hard disk error	Reload BIOS default setting Hard disk System board
09XXX	CD-ROM error	Reset CD-ROM cable CD-ROM drive System board
10XXX	Co-processor error	System board
11XXX	Pointing device error	Reset Keyboard Keyboard System board
12XXX	Cache test error	System board

Jumper and Connector Locations

Top View

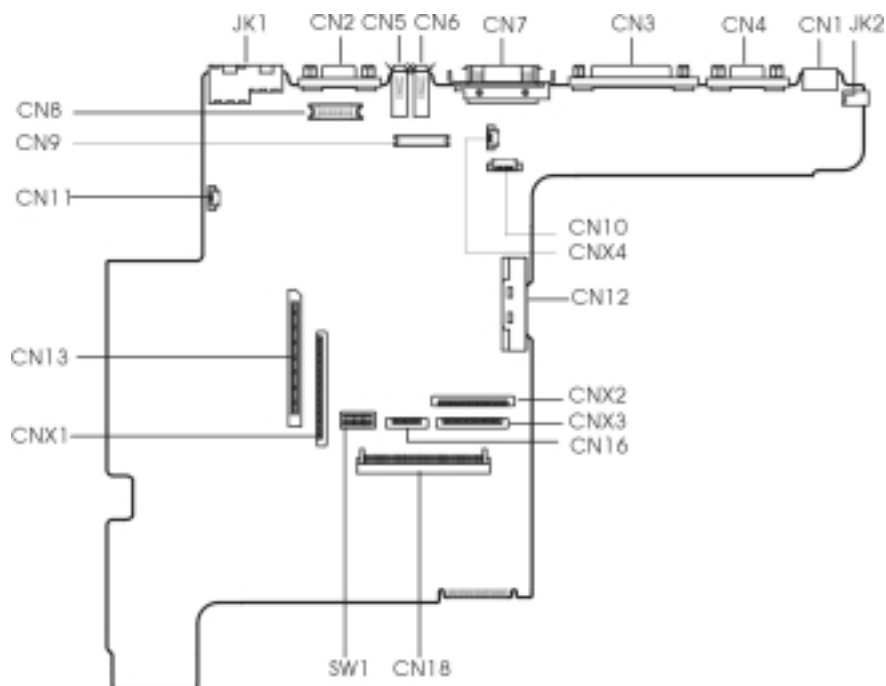

PCB No. 99206

CN1	PS/2 keyboard and Mouse Port	CN12	CD-ROM Connector
CN2	External Display Port	CN13	PCMCIA Socket Connector
CN3	Parallel Port	CN16	Touch Pad Cable Connector
CN4	Serial Port	CN18	Hdd Connector
CN5	USB Port 1	CNX1	Diskette Drive Connector
CN6	USB Port 2	CNX2	Keyboard Cable Connector
CN7	Expansion Port	CNX3	Digital finger Print Sensor Connector (For castor only)
CN8	LED & Inverter Connector	CNX4	TV BD Connector
CN9	LCD Connector	JK1	Modem / Lan Port
CN10	Cover Switch	JK2	DC-in Port
CN11	Launch Key Connector	SW1	Switch

Keyboard Switch Settings

	SW-1	SW-2	SW-3
English	OFF	OFF	Reserved
Japanese	ON	OFF	Reserved
UK	OFF	ON	Reserved
English-International	OFF	OFF	Reserved

SW-4/5

	SW-4	SW-5
Acer	OFF	OFF

SW-6: Check Password

SW6 = OFF, Enable

SW-6 = ON, Disable

SW-7: Boot Block Boot

SW-7 = OFF, Disable

SW-7 = On, Enable

Bottom View

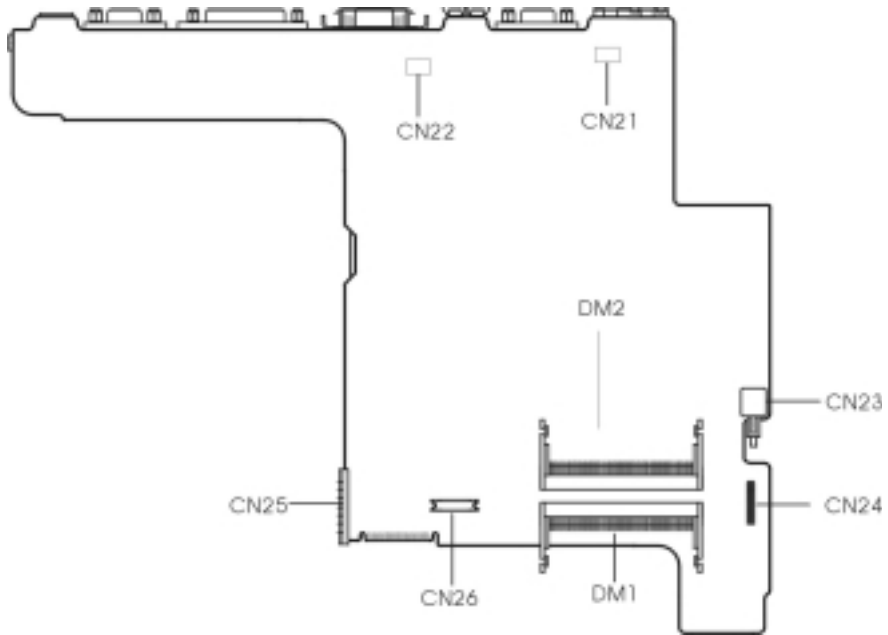

CN21	Modem Card Cable Connector	CN25	Battery Connector
CN22	Modem Card Cable Connector	CN26	Modem Connector
CN23	Power Push Switch	DM1	DIMM 1 Socket
CN24	Audio Connector	DM2	DIMM 2 Socket (Reverse)

FRU (Field Replaceable Unit) List

¹This chapter gives you the FRU (Field Replaceable Unit) listing in global configurations of TravelMate 520. Refer to this chapter whenever ordering for parts to repair or for RMA (Return Merchandise Authorization).

Please note that WHEN ORDERING FRU PARTS, you should check the most up-to-date information available on your regional web or channel. For whatever reasons a part number change is made, it will not be noted on the printed Service Guide. For ACER AUTHORIZED SERVICE PROVIDERS, your Acer office may have a DIFFERENT part number code from those given in the FRU list of this printed Service Guide. You MUST use the local FRU list provided by your regional Acer office to order FRU parts for repair and service of customer machines.

NOTE: To scrap or to return the defective parts, you should follow the local government ordinance or regulations on how to dispose it properly, or follow the rules set by your regional Acer office on how to return it.

¹ The part number of the exploded drawing is for reference only, for the most updated information, please refer to the Spare Parts List database.

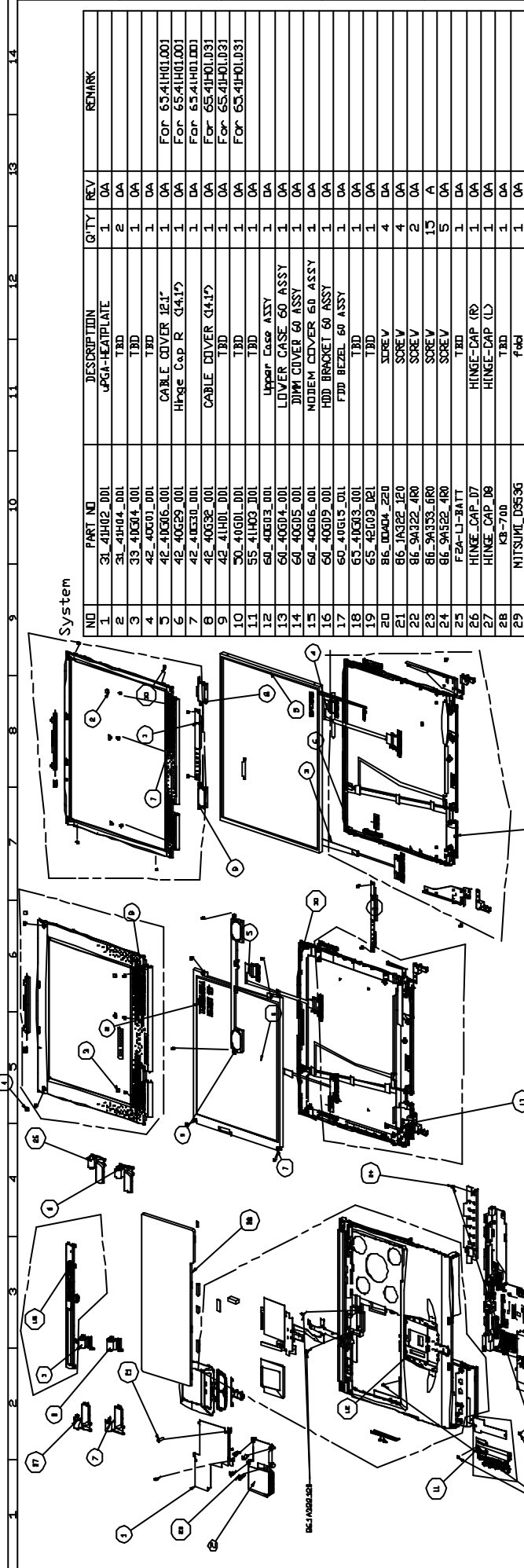

NO	PART NO	DESCRIPTION	QTY	REV	REMARK
1	31.41H02.001	UPGA-HEATPLATE	1	0A	
2	31.41H04.001	TBD	2	0A	
3	33.41H04.001	TBD	1	0A	
4	42.40G01.001	TBD	1	0A	
5	42.41H06.001	CABLE DRIVER 12.1"	1	0A	
6	42.40G29.001	Hinge Cap R (14.1")	1	0A	For 65.41H01.001
7	42.41H03.001	TBD	1	0A	For 65.41H01.001
8	42.40G32.001	CABLE DRIVER (14.1")	1	0A	For 65.41H01.001
9	42.41H01.001	TBD	1	0A	For 65.41H01.001
10	50.41G01.001	TBD	1	0A	
11	55.41H03.001	TBD	1	0A	
12	60.4E003.001	Upper Case Assy	1	0A	
13	60.40M04.001	LOWER CASE 60 ASSY	1	0A	
14	60.40G05.001	DOWN DRIVER 60 ASSY	1	0A	
15	60.40G06.001	NOISEM DRIVER 60 ASSY	1	0A	
16	60.40G09.001	HDD BRACKET 60 ASSY	1	0A	
17	60.41G15.001	FDD BEZEL 60 ASSY	1	0A	
18	65.41H03.001	TBD	1	0A	
19	65.42103.001	TBD	1	0A	
20	86.10M04.200	SCREW	4	0A	
21	86.1A322.120	SCREW	4	0A	
22	86.9A322.480	SCREW	2	0A	
23	86.9A333.600	SCREW	15	A	
24	86.9A522.400	SCREW	5	0A	
25	F2A-L1-BATT	TBD	1	0A	
26	HINGE_CAP_D7	HINGE-CAP (R)	1	0A	
27	HINGE_CAP_D8	HINGE-CAP (L)	1	0A	
28	KB-700	TBD	1	0A	
29	MTSUSHI_D8536	FDD	1	0A	

NO	PART NO	DESCRIPTION	QTY	REV	REMARK
1	19.21030.A41	Inverter-board	1	0A	
2	34.41G14.001	MEGNET	1	0A	
3	47.40G02.001	MEGNET	3	0A	
4	47.49A02.001	CUSHION RUBBER SCREW UP	2	0A	
5	50.40G06.001	LED-INVERTER WIRE CABLE	1	0A	
6	50.40G07.011	COAXIAL CABLE(KH71217)	1	0A	
7	56.0741G.001	LED	1	0A	
8	60.41G11.001	LCD BEZEL ASSY (12.1")	1	0A	
9	60.40G02.011	SPEAKER3.2x12.2	1	0A	
10	60.41H02.001	LCD PANEL ASSY(RH11E1)FL2.5	1	0A	
11	86.9A553.400	SCREW	11	0A	

NO	PART NO	DESCRIPTION	QTY	REV	REMARK
1	19.21030.A41	Inverter-board	1	0A	
2	47.40G02.001	MEGNET	3	0A	
3	50.41H01.001	COAXIAL CABLE(14.1")	1	0A	
4	50.41H02.001	LED-INVERTER WIRE CABLE FILE.5	1	0A	
5	56.0749C.051	LED	1	0A	
6	60.41H02.001	LCD PANEL ASSY(KAD14.1)FILE.5	1	0A	
7	60.41H03.001	LCD BEZEL ASSY (14.1")	1	0A	
8	60.41H04.001	SPEAKER-RO(14.1")	1	0A	
9	60.41H05.001	SPEAKER-L(14.1")	1	0A	
10	86.9A322.480	SCREW	4	0A	
11	86.9A553.400	SCREW	7	0A	

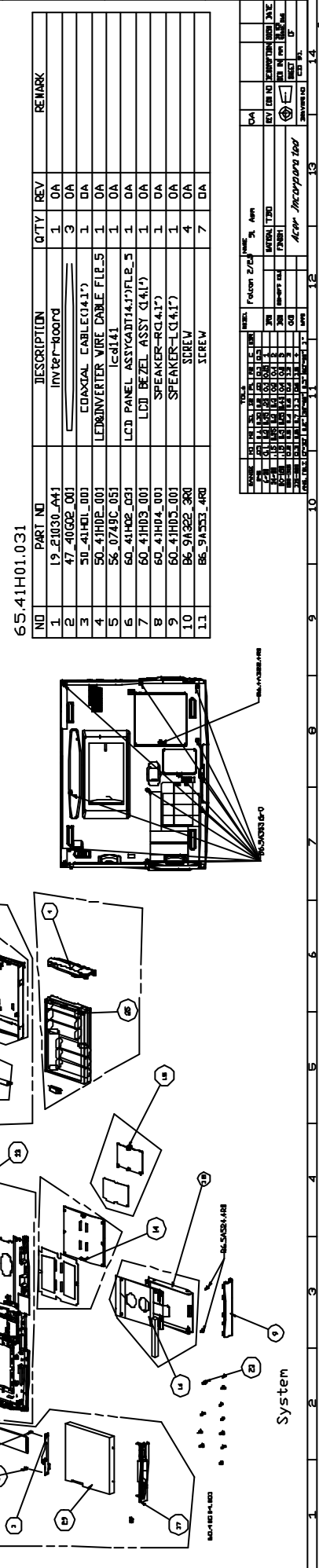







NO	PART NO	DESCRIPTION	QTY	REV	REMARK
1	31.41H02.001	UPGA-HEATPLATE	1	0A	
2	31.41H04.001	TBD	2	0A	
3	33.41H04.001	TBD	1	0A	
4	42.40G01.001	TBD	1	0A	
5	42.41H06.001	CABLE DRIVER 12.1"	1	0A	
6	42.40G29.001	Hinge Cap R (14.1")	1	0A	
7	42.41H03.001	TBD	1	0A	
8	42.40G32.001	CABLE DRIVER (14.1")	1	0A	
9	42.41H01.001	TBD	1	0A	
10	50.41G01.001	TBD	1	0A	
11	55.41H03.001	TBD	1	0A	
12	60.4E003.001	Upper Case Assy	1	0A	
13	60.40M04.001	LOWER CASE 60 ASSY	1	0A	
14	60.40G05.001	DOWN DRIVER 60 ASSY	1	0A	
15	60.40G06.001	NOISEM DRIVER 60 ASSY	1	0A	
16	60.40G09.001	HDD BRACKET 60 ASSY	1	0A	
17	60.41G15.001	FDD BEZEL 60 ASSY	1	0A	
18	65.41H03.001	TBD	1	0A	
19	65.42103.001	TBD	1	0A	
20	86.10M04.200	SCREW	4	0A	
21	86.1A322.120	SCREW	4	0A	
22	86.9A322.480	SCREW	2	0A	
23	86.9A333.600	SCREW	15	A	
24	86.9A522.400	SCREW	5	0A	
25	F2A-L1-BATT	TBD	1	0A	
26	HINGE_CAP_D7	HINGE-CAP (R)	1	0A	
27	HINGE_CAP_D8	HINGE-CAP (L)	1	0A	
28	KB-700	TBD	1	0A	
29	MTSUSHI_D8536	FDD	1	0A	

NO	PART NO	DESCRIPTION	QTY	REV	REMARK
1	19.21030.A41	Inverter-board	1	0A	
2	47.40G02.001	MEGNET	3	0A	
3	50.41H01.001	COAXIAL CABLE(14.1")	1	0A	
4	50.41H02.001	LED-INVERTER WIRE CABLE FILE.5	1	0A	
5	56.0749C.051	LED	1	0A	
6	60.41H02.001	LCD PANEL ASSY(KAD14.1)FILE.5	1	0A	
7	60.41H03.001	LCD BEZEL ASSY (14.1")	1	0A	
8	60.41H04.001	SPEAKER-RO(14.1")	1	0A	
9	60.41H05.001	SPEAKER-L(14.1")	1	0A	
10	86.9A322.480	SCREW	4	0A	
11	86.9A553.400	SCREW	7	0A	

Picture	No.	Partname	Description	Part No.
CPU/ Processor				
	NS	CPU, PIII-500, INTEL	IC CPU COPPERM-500 UPGA2	01.COPRM.50A
		CPU, PIII-600, INTEL	IC CPU COPP600 W/GEY UPGA2	01.COPRM.60C
Memory				
	NS	DIMM,64M,PC100, Siemens	SDIMM 64M HYS64V8220GCDL-8B(SI)	72.64820.B0N
	NS	DIMM,64M,PC100, Winbond	DIMM 64M 8*16 W17064IHNC86220	72.17064.00N
LCD				
	NS	LCD module	LCD MODULE(HIT12.1")FL2.5	6M=65.41H01.001
	7	LCD , 12.1" TFT, HITACHI	LCD 12.1SVGA HIT/ TX31D35VCICCA	56.0740G.001
	1	Inverter	INVERTER T62I172.00 FALCON2	19.21030.A41
	5	Inverter cable	C.A LED&INV(12.1"&13.3)FL2	50.40G06.001
	6	LCD cable	COAXIALCABLE(HIT12.1")	50.40G07.011

Picture	No.	Partname	Description	Part No.
	8	LCD bezel	LCD BEZEL ASSY(12.1")	60.40G11.001
	10	LCD panel	LCD PANEL ASSY(HIT12.1")FL2.5	60.41H02.001
	NS	Hinge Bracket Pack	HINGE BRACKET PACK	6K=34.40G07.001+34.40G08.001
	9	Speaker	SPEAKER13.3& 12.1	60.40G12.011
	NS	LCD module	LCD MODULE(ADT14.1")F2.5	6M=65.41H01.041
	5	LCD , 14.1" TFT, IBM	LCD 14.1"IBM/ITXG76C	56.0749C.051
	1	Inverter	INVERTER T62I172.00 FALCON2	19.21030.A41
	4	Inverter cable	C.ALED&INV(14.1")FL2.5	50.41H02.001







Picture	No.	Partname	Description	Part No.
	3	LCD cable	C.A LCD(14.1"ADT&UNI)FL2.5	50.41H01.001
	7	LCD bezel	LCD BEZEL ASSY(14.1")	60.41H03.001
	6	LCD panel	LCD PNL ASSY(ADT14.1")FL2.5	60.41H02.031
	NS	Hinge Bracket Pack	HINGE BRACKET PACK	6K=34.41H01.001+34.4 1H02.001
	8, 9	Speaker Pack	SPEAKER PACK	6K=60.41H04.001+60.4 1H05.001
HDD/ Hard Disk Drive				
	NS	HDD module	ASSY HDD FALCON 2	6M=65.40G05.001
	NS	HDD, 6G, IBM	HDD SM 9.5"6G IBM/ DARA206000	56.02A02.041
	16	HDD Bracket	HDD ASSY(9.5mm) BRACKET FALCON2	60.40G09.001







Picture	No.	Partname	Description	Part No.
	NS	HDD Connector	CONN CTR ML 22P HH98227-A2(HDD)	20.80056.022
	NS	HDD module	ASSYHDD9.5" 12GB IBM	6M=65.40G05.021
	NS	HDD, 12G, IBM	HDD SM9.5"12G IBM/ DARA212K A51	56.02A24.002
	16	HDD Bracket	HDD ASSY(9.5mm) BRACKET FALCON2	60.40G09.001
	NS	HDD Connector	CONN CTR ML 22P HH98227-A2(HDD)	20.80056.022
FDD/ Floppy Disk Drive				
	NS	FDD Module, Panasonic	FDD(PANASONIC)ASSY	6M=65.40G04.001
	NS	FDD Device, Panasonic	FDD 1.44SLIM MCI/ JU226A252FC(H)	56.01041.671

Picture	No.	Partname	Description	Part No.
	10	FDD Cable	C.A FDD FPC FALCON2	50.40G01.001
	3	FDD Bracket	FDD REAR BRAKET FALCON2	33.40G04.001
	17	FDD Bezel	FDD BEZEL(PANASONIC) ASSY	60.40G15.011
CD-ROM Drive				
	NS	CD-ROM Module,24X,MKE	CD/DVD-ROM Module	6M=65.40G10.001
	NS	CD-ROM Device,24X,MKE	CD ROM 24X MKE/CR176- BAA	56.10251.031
	NS	CD-ROM Chassis Assembly	CD/DVD-ROM ASSY	60.40G13.001
	NS	CD-ROM Board	FALCON-2 CD-ROM BD	55.40G04.D01

Picture	No.	Partname	Description	Part No.
	NS	CD-ROM Module,24X,TEAC	ASSY CDROM TEAC FALCON2	6M=65.40G06.001
	NS	CD-ROM Device,24X,TEAC	CD ROM 24X SLIM TEAC/ CD224EB26	56.10061.211
	NS	CD-ROM Chassis Assembly	CD/DVD-ROM ASSY	60.40G13.001
	NS	CD-ROM Board	FALCON-2 CD-ROMBD	55.40G04.D01
Fan				
	NS	FAN	FAN 5V 45*45*10 AB4505MB-GD3(B)	23.10041.011
Microphone				
	NS	Microphone Rubber	MIC-RUBBER CR PLATINUM	42.49A11.001
	NS	Microphone with Cable	MIC CABLE	50.40G06.011

Picture	No.	Partname	Description	Part No.
Heatsink				
	NS	CPU Heatsink	HEATSINK CPU FALCON2.5	34.41H04.001
	1	CPU Heatsink Plate	CPU HEATSINK PLATE FALCON2.5	31.41H02.001
	NS	PCMCIA Plate	PCMCIA PLATE FALCON 2.5	31.41H03.001
Pointing Device				
	NS	TouchPad FPC Cable	C.A TOUCHPAD FPC FALCON2	50.40G02.001
	NS	TouchPad Frame	TOUCH PAD FRAME FALCON2	41.40G01.001
	NS	TouchPad Board	TOUCHPAD MULTI- SWITCH SYNAPTIC	56.1740C.001
	NS	TouchPad Button	TOUCH PAD BUTTON FALCON2	42.40G09.001
	NS	TouchPad Scroll Button	TOUCH PAD SCROLL BUTTON FLCON2	42.40G10.001

Picture	No.	Partname	Description	Part No.
Cables				
	NS	Modem Cable	C.AMODEMFALCON2.5	50.41H04.001
	NS	Launch Board Cable	C.ALAUNCH FALCON2	50.40G05.001
Main board				
	NS	Main board/TM520	FALCON 2.5 MB C-500	55.41H01.S01
Boards				
	11	Audio Board	FALCON2.5 AUDIO BD	55.41H03.D01
	NS	Launch Board	FALCON2 LAUNCH BOARD	55.40G03.D01
	NS	Modem Board	AMBIT 56K MODEM MODULE UL 3.0	54.09011.311
PCMCIA Slot/ PC Card Slot				
	NS	PCMCIA Slot	SKT PCMCIA QT611366-3110C SMD	62.10024.111

Picture	No.	Partname	Description	Part No.
Battery				
	NS	Battery	ASSY BTY PACK BTP-34A1 FAL2.5	60.41H01.001
	NS	RTC Battery, Li	BTY LI 3V CR1220 36MAH	23.20004.091
Case/Cover/Bracket Assembly				
	5	LCD Cable Cover	CABLE COVER FALCON2	42.40G06.001
	NS	Middle Cover	MIDDLECOVER FALCON2	42.40G04.001
	26, 27	Hinge Cap Pack	ASSY HINGE PACK	6K=42.40G08.001+42. 40G07.001
	14	Memory Cover	DIMM COVER ASSY	60.40G05.001
	NS	HDD Cover	ASSY HDD COVER FALCON2.5	60.41H14.001

Picture	No.	Partname	Description	Part No.
	15	Modem Cover	MODEM COVER ASSY	60.40G06.001
	12	Upper Case	UPPERCASE ASSEMBLY	60.40G03.001
	NS	Lower Case	LOWER CASE(F2.5)	60.41H06.001
	NS	Charger Plate with Thermal pad	ASSY CARGER PLATE FALCON2.5	60.41H13.001
Miscellaneous				
	NS	Camera Rubber	RUBBER CAMERA TM340	47.40F07.002
	NS	LOGO	LOGO	40.42F09.001
Screws				
	11	Main board Screw	SCREW M2.5*4L NI	86.9A553.4R0
	22	Modem Cover Screw	SCREWM2.0X4(BLACK)	86.9A322.4R0
	23	Hinge Screw	SCREW M2.5X6	86.9A353.6R0
	21	HeatSink Screw	SCREWM2.0*12 STEELB	86.1A322.120
	NS	CD-ROM Screw	SCREW M2-3	86.9A522.3R0
	NS	CD-ROM Mylar Screw	SCREW SPECIAL M2 FALCON2	86.00A03.220
	10	LCD Screw	SCRW BIND M2*L3 B-ZN SHIVA	86.9A322.3R0
	20	CPU Screw	SCREW CPU FALCON2.5	86.00A04.220
	NS	CPU Spring	SPRING CPU FALCON2.5	34.41H05.001

Model Definition and Configuration

Model Number Definitions

Model Number	LCD	CPU	Memory	HDD	CD	Battery
520iT	12.1" TFT	Celeron-550	64MB	4.8GB	24x	Lilon
521TE	13.3" TFT	PIII-600	64MB	6GB	24x	Lilon
521TX	14.1 TFT	PIII-600	64MB	6GB	24x	Lilon
521TXV	14.1 TFT	PIII-600	64MB	6GB	6x DVD	Lilon
522TX	14.1 TFT	PIII-600	64MB	12GB	24x	Lilon
522TXV	14.1 TFT	PIII-600	64MB	12GB	6x DVD	Lilon
523TE	13.3 TFT	PIII-600	64MB	6GB	24x	Lilon
524TX	14.1 TFT	PIII-600	64MB	12GB	24x	Lilon
524TXV	14.1 TFT	PIII-600	64MB	12GB	6x DVD	Lilon
525TX	14.1 TFT	PIII-600	64MB	12GB	24x	Lilon
525TXV	14.1 TFT	PIII-600	64MB	12GB	6x DVD	Lilon

Test Compatible Components

This computer's compatibility is tested and verified by Acer's internal testing department. All of its system functions are tested under Windows 95, Windows 98, Windows 2000 and Windows NT environment.

Refer to the following lists for components, adapter cards, and peripherals which have passed these tests. Regarding configuration, combination and test procedures, please refer to the TravelMate 520 Compatibility Test Report released by the Acer Mobile System Testing Department.

TravelMate 520 Compatibility Test Report is not yet ready when the service guide was released. Test Compatible Components will not be provided at this moment. Please check website for updates of test compatible components.

Online Support Information

This section describes online technical support services available to help you repair your Acer Systems.

If you are a distributor, dealer, ASP or TPM, please refer your technical queries to your local Acer branch office. Acer Branch Offices and Regional Business Units may access our website. However some information sources will require a user i.d. and password. These can be obtained directly from Acer CSD Taiwan.

Acer's Website offers you convenient and valuable support resources whenever you need them.

In the Technical Information section you can download information on all of Acer's Notebook, Desktop and Server models including:

- Service guides for all models
- User's manuals
- Training materials
- Main manuals
- Bios updates
- Software utilities
- Schematics
- Spare parts lists
- Chips
- TABs (Technical Announcement Bulletin)

The service repair section provides you with downloadable information on:

- Troubleshooting guides
- Tooling box information
- Repair instructions for specific models
- Basic repair guidelines
- Debug cards for Acer's latest models

For these purposes, we have included an Acrobat File to facilitate the problem-free downloading of our technical material.

Also contained on this website are:

- Detailed information on Acer's International Traveller's Warranty (ITW)
- Returned material authorization procedures
- An overview of all the support services we offer, accompanied by a list of telephone, fax and email contacts for all your technical queries.

We are always looking for ways to optimize and improve our services, so if you have any suggestions or comments, please do not hesitate to communicate these to us.

A

AC Adapter 25
 ACPI 1
 AFLASH Utility 37
 Audio 21

B

Battery 23
 Battery Cover
 Removing 47
 Battery Pack
 Removing 47
 BIOS 17
 BIOS Setup Utility 29
 BIOS Utility 29–36
 Basic System Settings 31
 Load Default Settings 36
 Navigating 29
 Onboard Device Configuration 33
 Startup Configuration 31
 System Information 30
 System Security 34
 Block Diagram 3
 Board Layout 4

C

CD-ROM 20
 CD-ROM Drive
 Disassembly 48
 Removing 48

D

DC-AC LCD Inverter 24
 DC-DC/Charger 23
 Disassembly Flowchart 45
 Diskette Drive Check 68
 Display Standby Mode 26
 DMA Channel Assignment 28
 DVD-ROM 20

E

Environmental Requirements 26
 External CD-ROM Drive Check 68

F

FDD 19
 Features 1
 Flash Utility 37
 FRU (Field Replaceable Unit) List 87

H

Hard Disk Drive Module
 Disassembly 49
 Removing 49
 Hard Disk Standby Mode 26
 Hardware Specifications and Configurations 17
 HDD 19
 Hibernation Mode 26
 Hot Keys 12

I

I/O Address Map 27
 Index of Error Message 71
 No-Beep Symptoms 73
 Index of Symptom-to-FRU Error Message 74
 Indicator 74
 Keyboard 76
 LCD 74
 Memory 75
 Modem 77
 PCMCIA 75
 Peripheral 76
 Power 74
 Power Management 75
 Speaker 75
 Touchpad 76
 Indicators 10
 Intermittent Problems 78
 IrDA
 setting in BIOS Utility 33
 IrDA Port 23
 IRQ Assignment Map 28

J

Jumper and Connector Locations
 Bottom View 85
 SW2 Settings 83
 Top View 83

K

- Keyboard 11, 23
- Keyboard or Auxiliary Input Device Check 68

L

- LAN 18
- Launch Keys 14
- LCD 2, 24
 - Disassembly 52

M

- Machine Disassembly and Replacement 43
- Major Chips 17
- Mechanical Specifications 27
- Memory 17
 - Removing 50
- Memory Address Map 27
- Memory Check 69
- Memory Combinations 18
- Model Number Definitions 99
- Modem 18

O

- Online Support Information 103

P

- Panel 6
 - Bottom Panel 9
 - Front Panel 6
 - Left Panel 7
 - Rear Panel 8
 - Right Panel 8
- Parallel Port 22
- parallel port
 - setting in BIOS Utility 33
- Password Setting
 - Hard Disk Password 35
 - Power-On Password 35
 - Setup Password 35
- PCMCIA Port 23
- Power System Check 69
 - Battery Pack 70
 - Power Adapter 69
- PQA 40
- Processor 17

R

- RMA 87

S

- Serial Port 22
- Speed Step technology 1
- Standby Mode 26
- SVGA 2
- System Check Procedures 68
- System Diagnostic Diskette 40
- System Specifications 1
- System Utilities 29
- System Utility Diskette 38

T

- Test Compatible Components 101
- TFT 2
- Touchpad 15
- Touchpad Check 70
- Troubleshooting 67

U

- Undetermined Problems 79
- USB Port 22
 - utility
 - BIOS 29–36

V

- Video 21
- Video Resolutions Mode 22

